

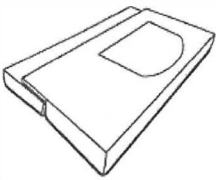







PLEASE ENSURE THERE NO PARTS MISSING BEFORE ASSEMBLY.

A SOFA	B PILLOW	C ARMREST	D ARMREST	E FRONT LEG	F BACK LEG	G SCREW	SUPPORT LEG
							
1PC	2PCS	1PC	1PC	2PCS	2PCS	8PCS	1PC

ATTENTION: THIS ITEM SHOULD BE ASSEMBLED ON A SOFT SURFACE TO PREVENT SCRATCHING THE FINISH DURING ASSEMBLY.

STEP 1 TAKE OUT THE LEGS, HARDWARE, ARMREST

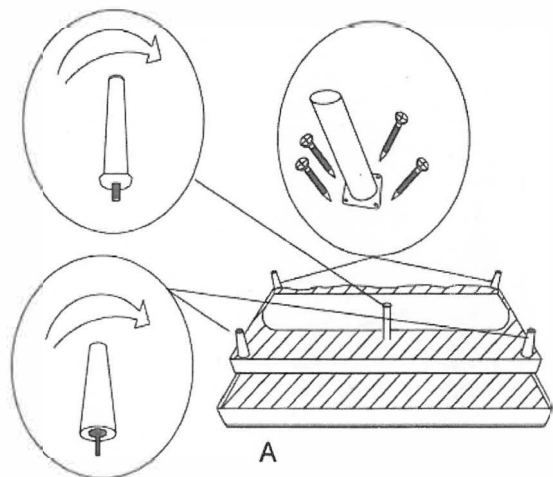
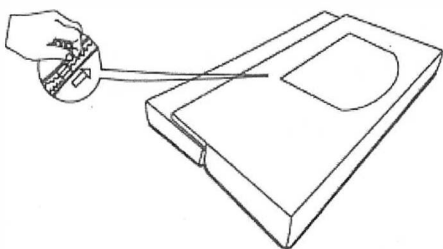

Step 2

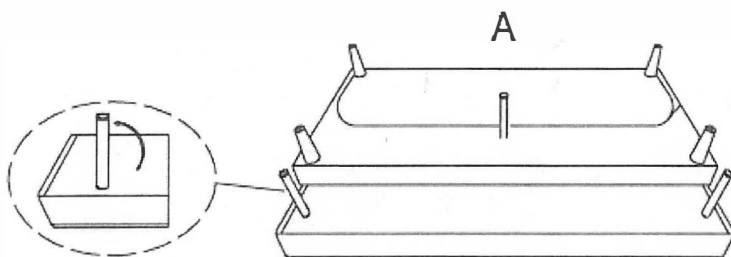

STEP 3

If you want to convert the sofa into bed, take out the supporting legs from the zipper, lift up the leg until it is on a 90 degree angel. From behind the sofa push forward to unlock the sofa to convert it into a bed.

