

# 230-000038

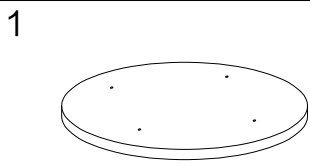

x1

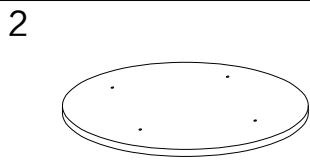

x1

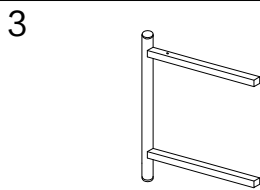

x1

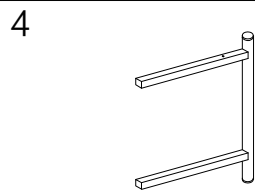

x1

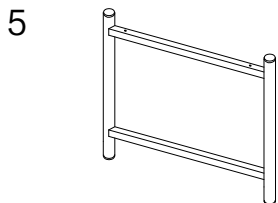

x1



( 6x30mm ) x8



( 6x10mm ) x6

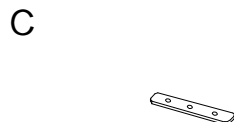

x2

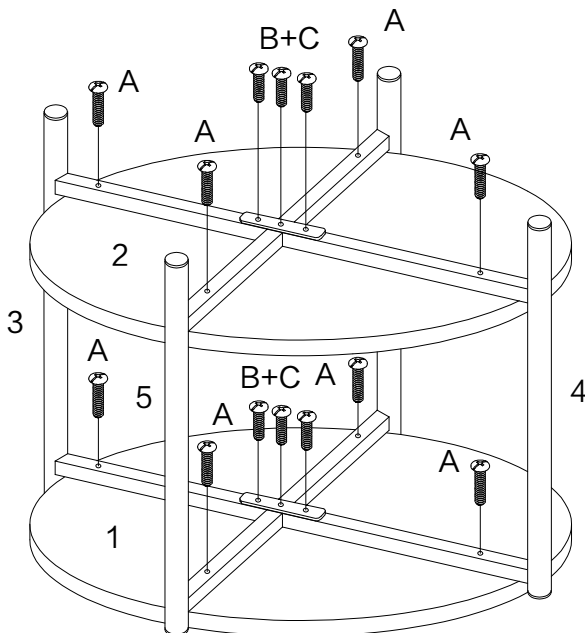

A	x8
C	x2
B	x6

Complete

