

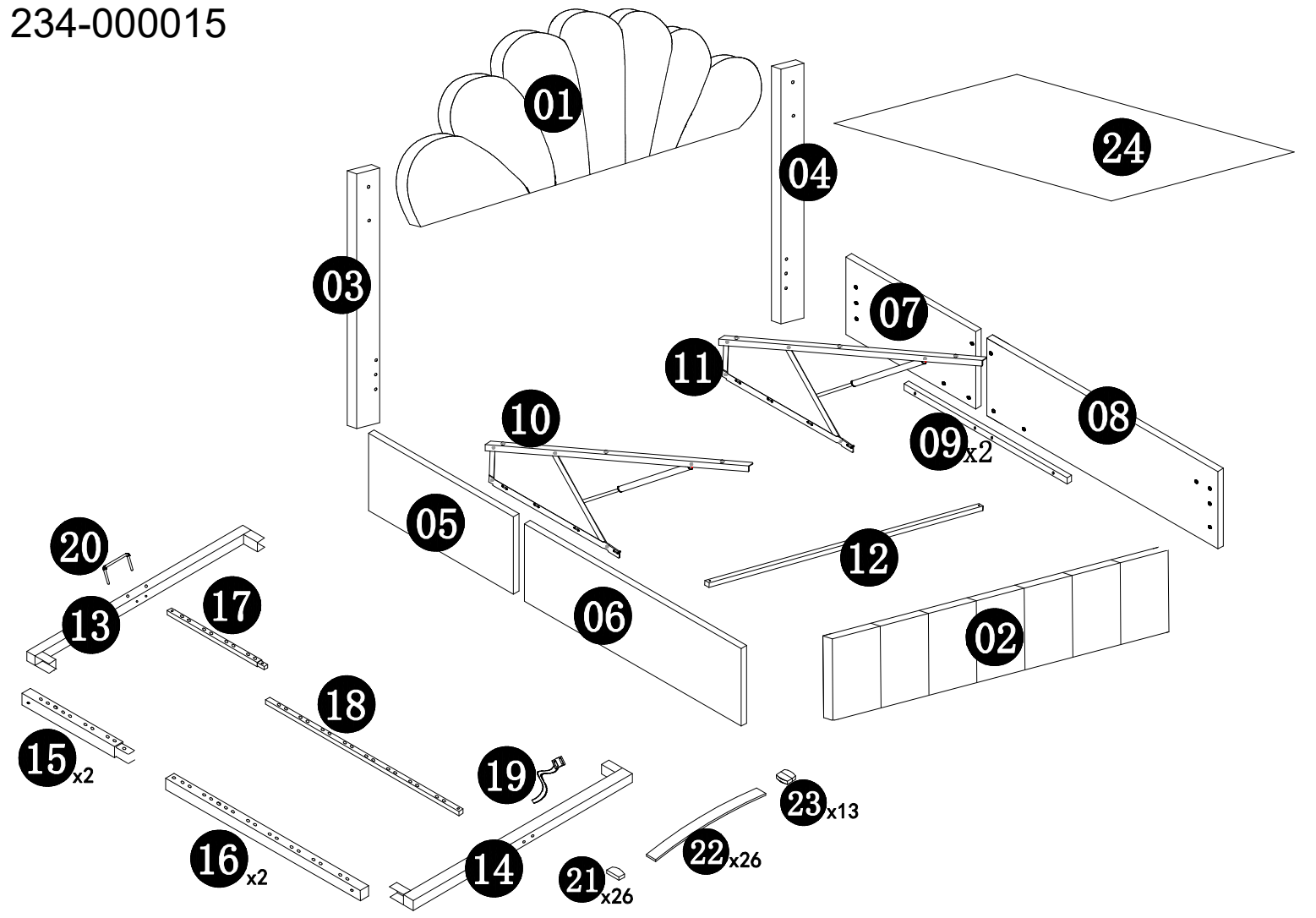









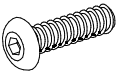

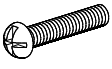

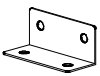
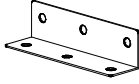



234-000015

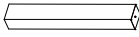

A	 8*20	42
B	 8*50	14
C	 8*40	2
D	 8*60	4
E	 8*40	12
F	 3.5*20	12
G		2

H		2
I		2
J		2
K		15
L		2
M		4
N		2

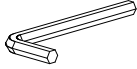
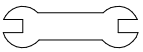

O	 21cm	3
P		5
Q		6
R		2
S	 2.5cm	2
T		1
U		1
V		1

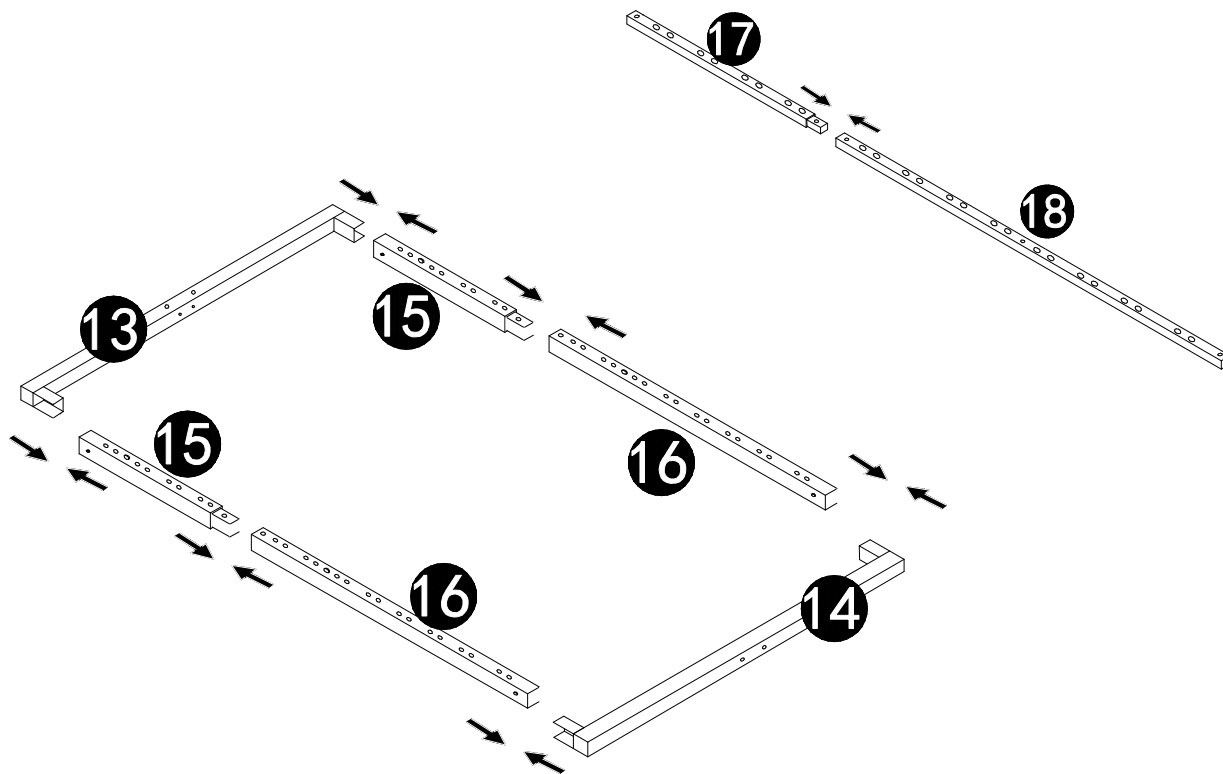

01

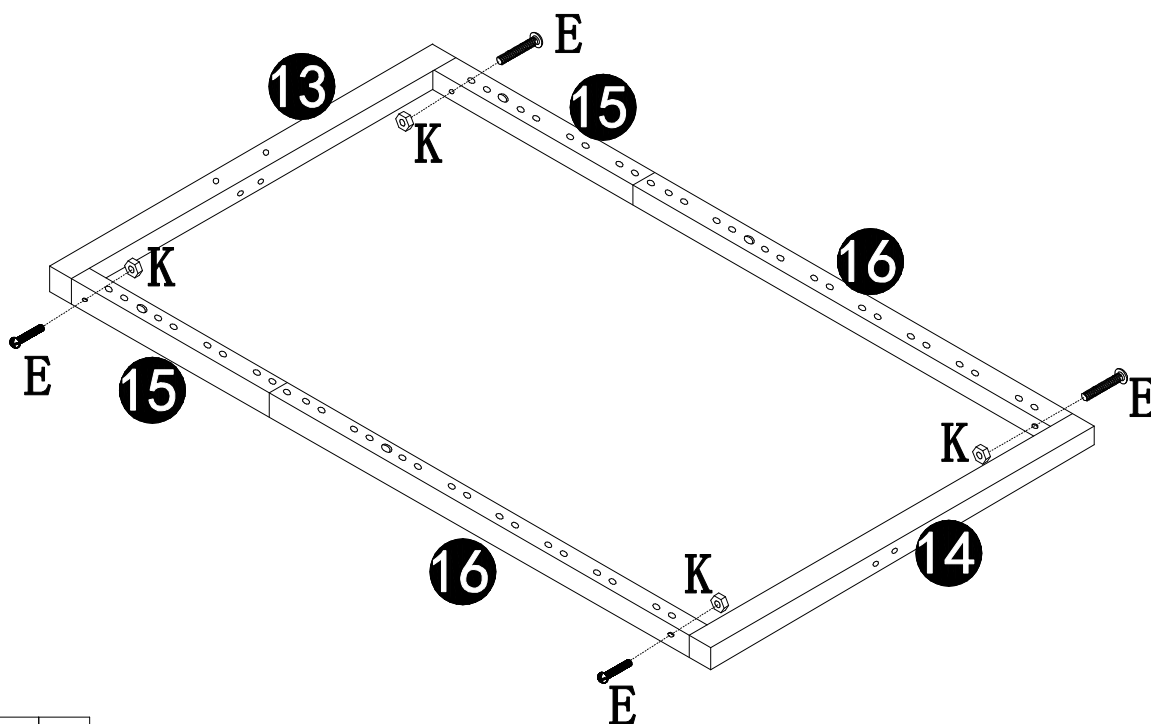

02





T		1
V		1



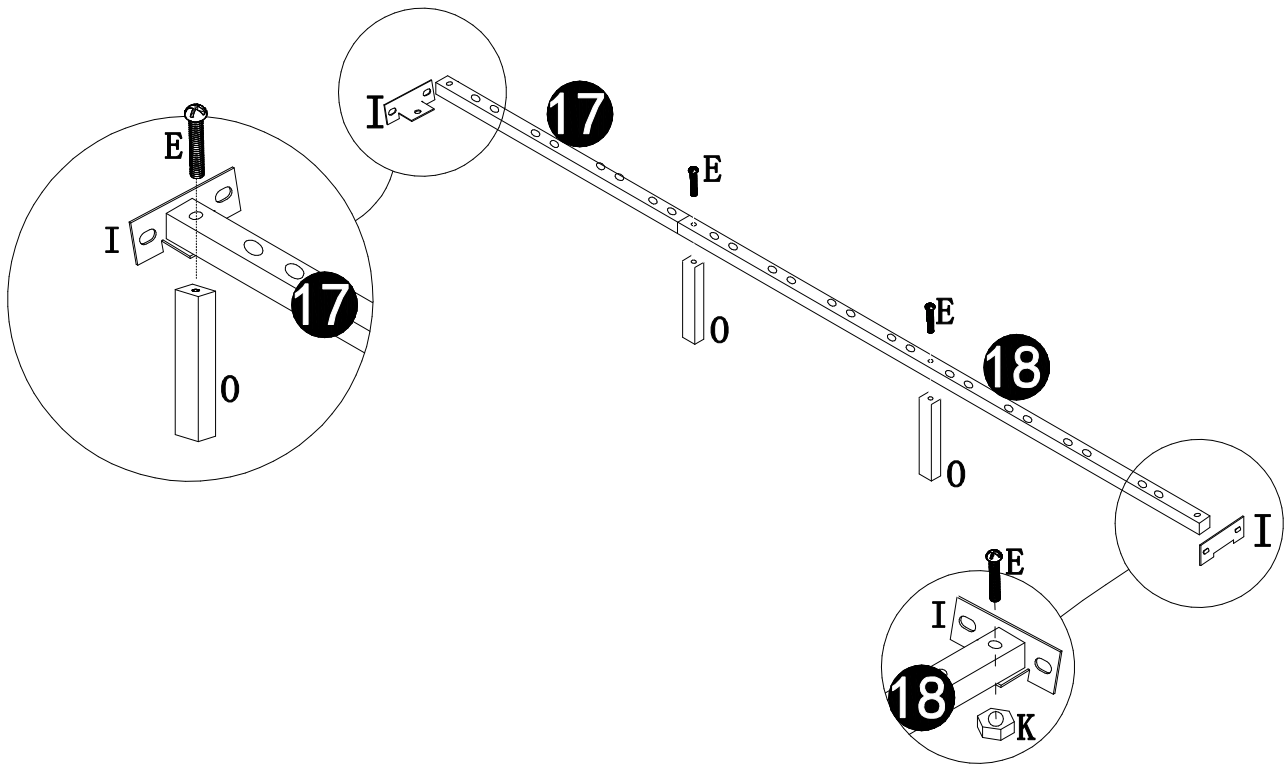

K		4	E		4
---	---------------------------------------------------------------------------------------	---	---	---------------------------------------------------------------------------------------	---

8*40

03

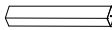



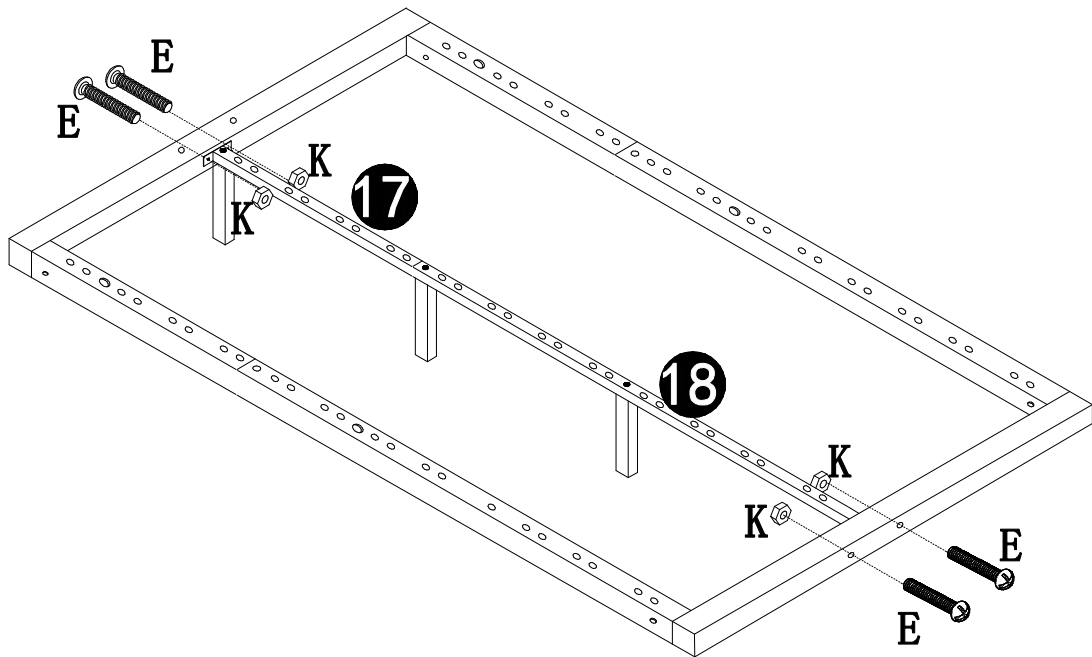

T		1
V		1

O	 21cm	3	K		1
I		2	E	 8*40	4

04



T		1
V		1

K		4	E	 8*40	4
---	---------------------------------------------------------------------------------------	---	---	-----------------------------------------------------------------------------------------------	---

05

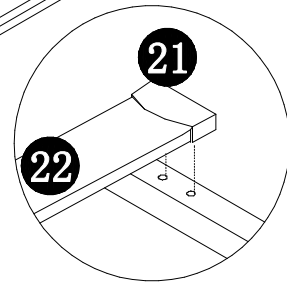
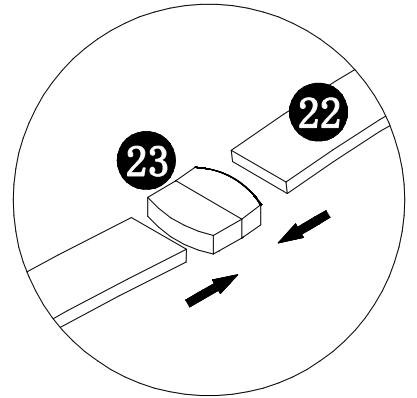
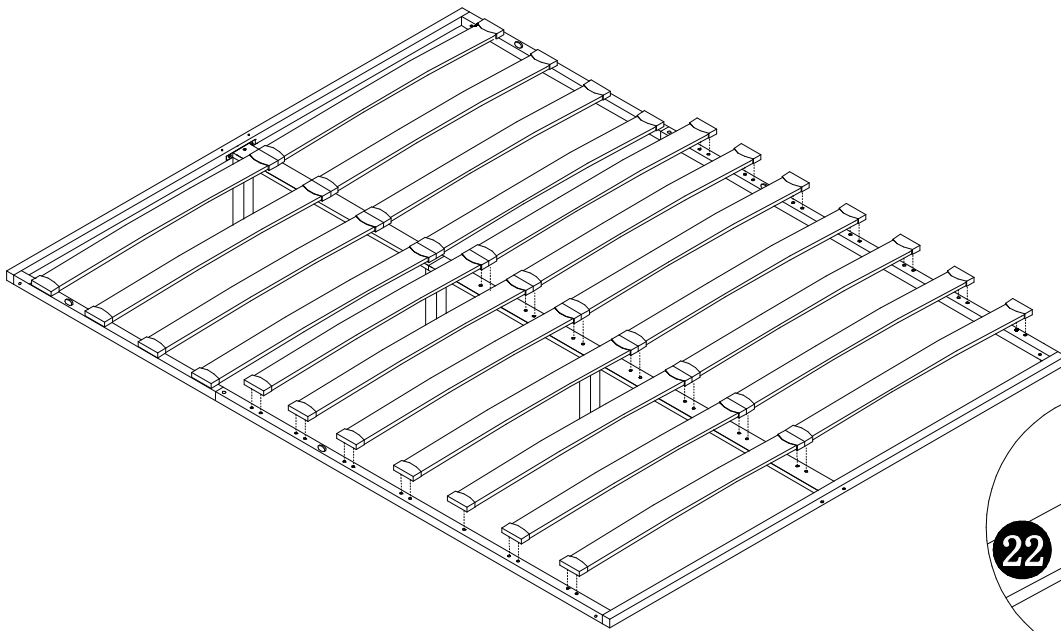

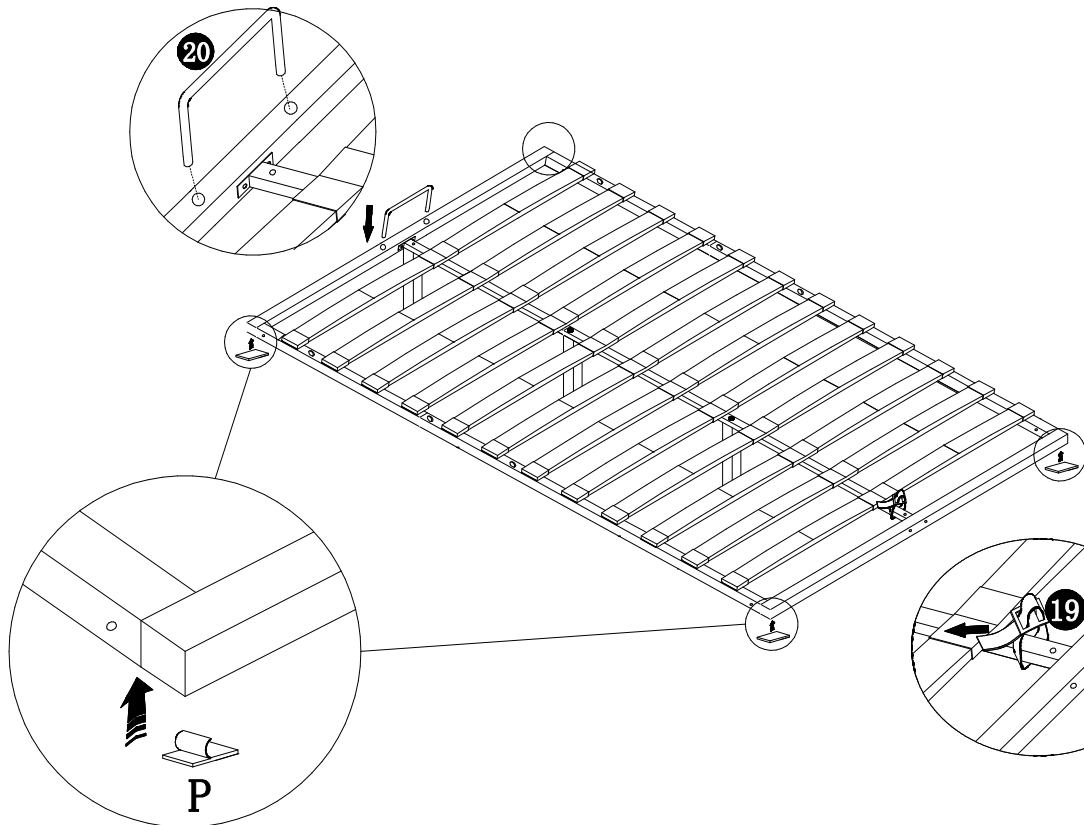

06

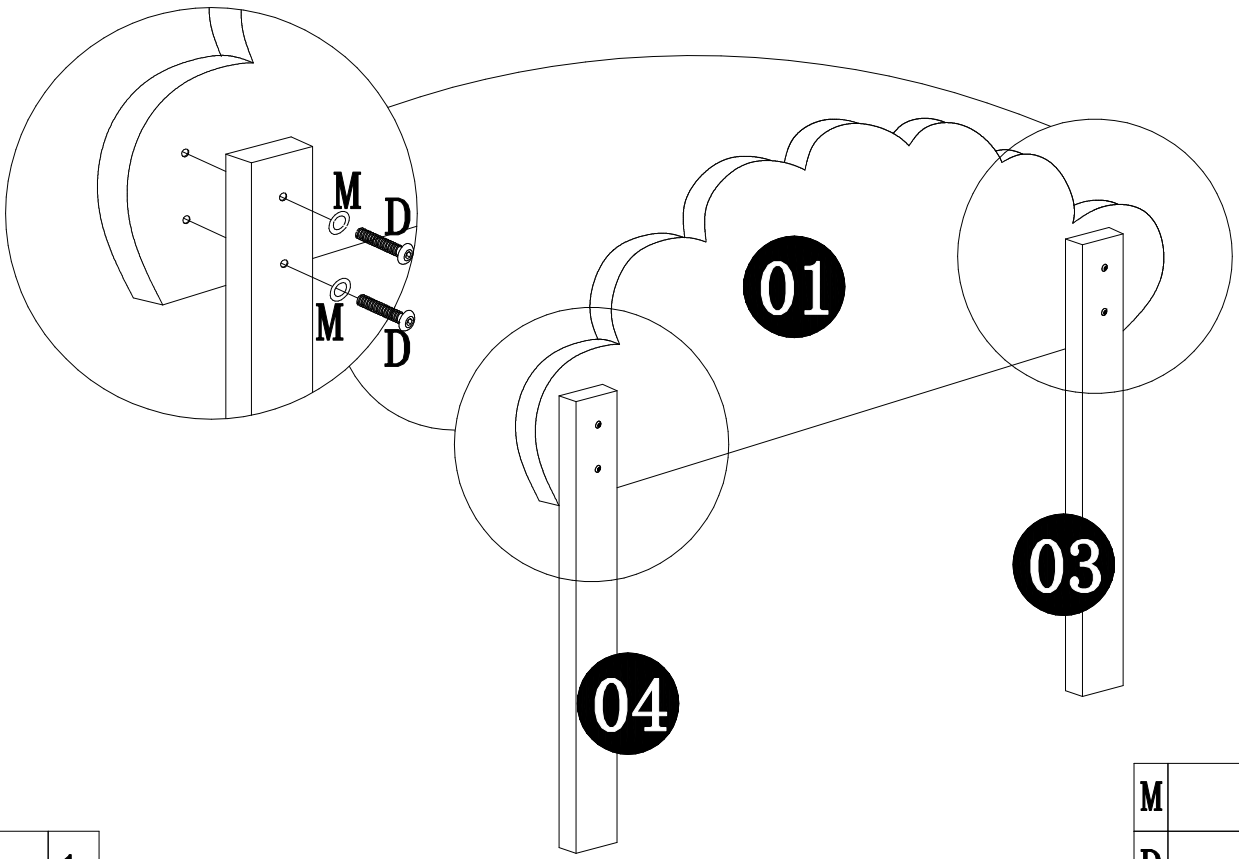

07





U		1
---	-------------------------------------------------------------------------------------	---

M		4
D	 8*60	4

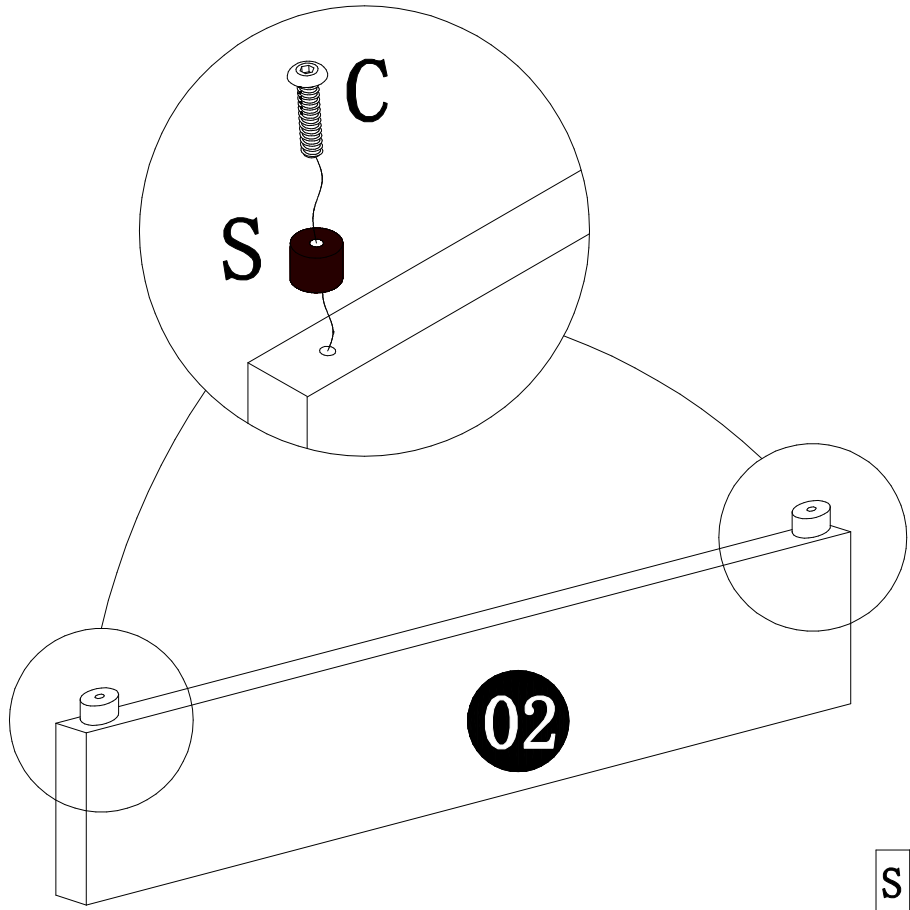
08



U		1
---	-------------------------------------------------------------------------------------	---

S	 2.5cm	2
C	 8*40	2

09

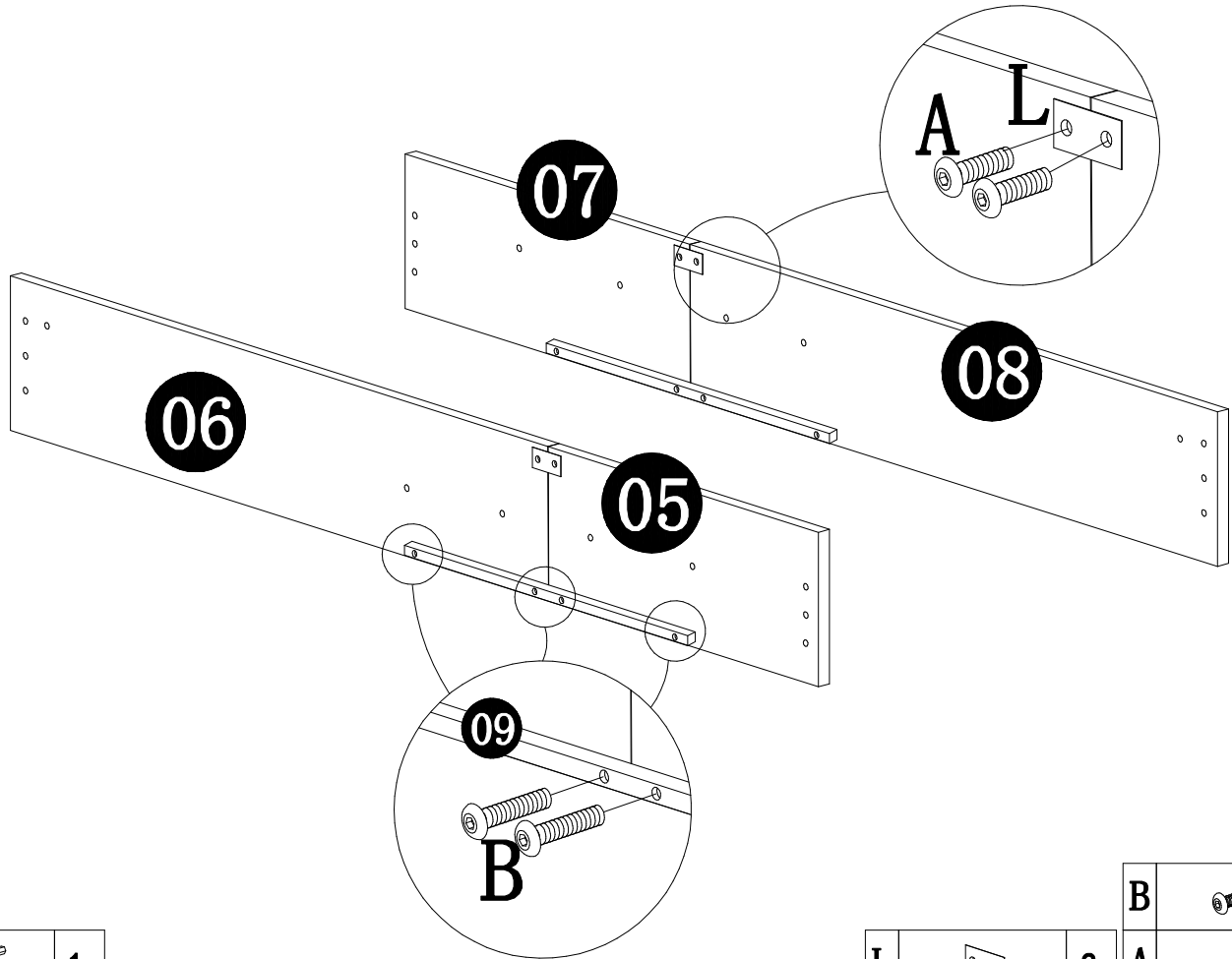

U		1
---	--	---

L		2	B		8
			A		4

10

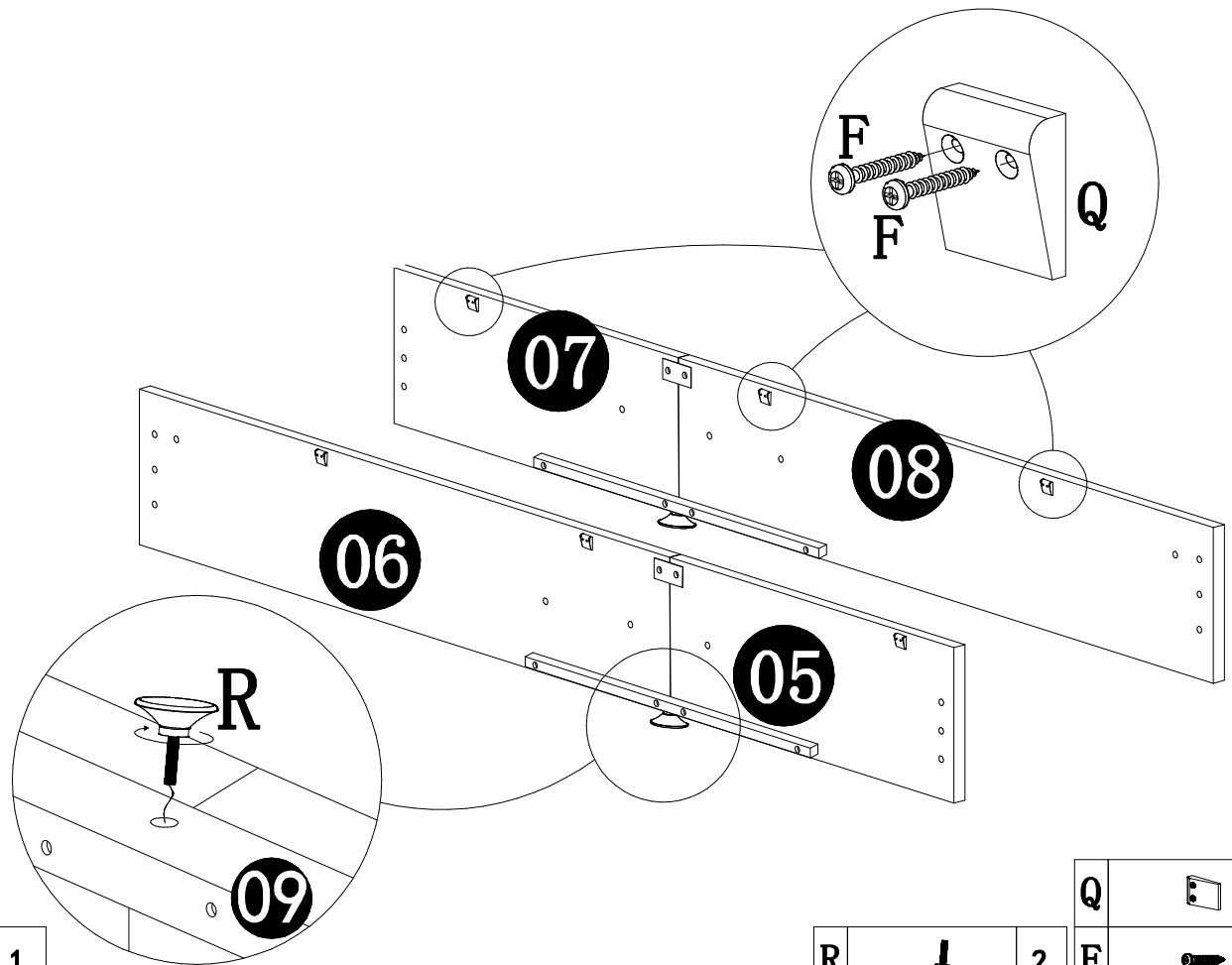

T		1
---	--	---

R		2	Q		6
			F		12

11

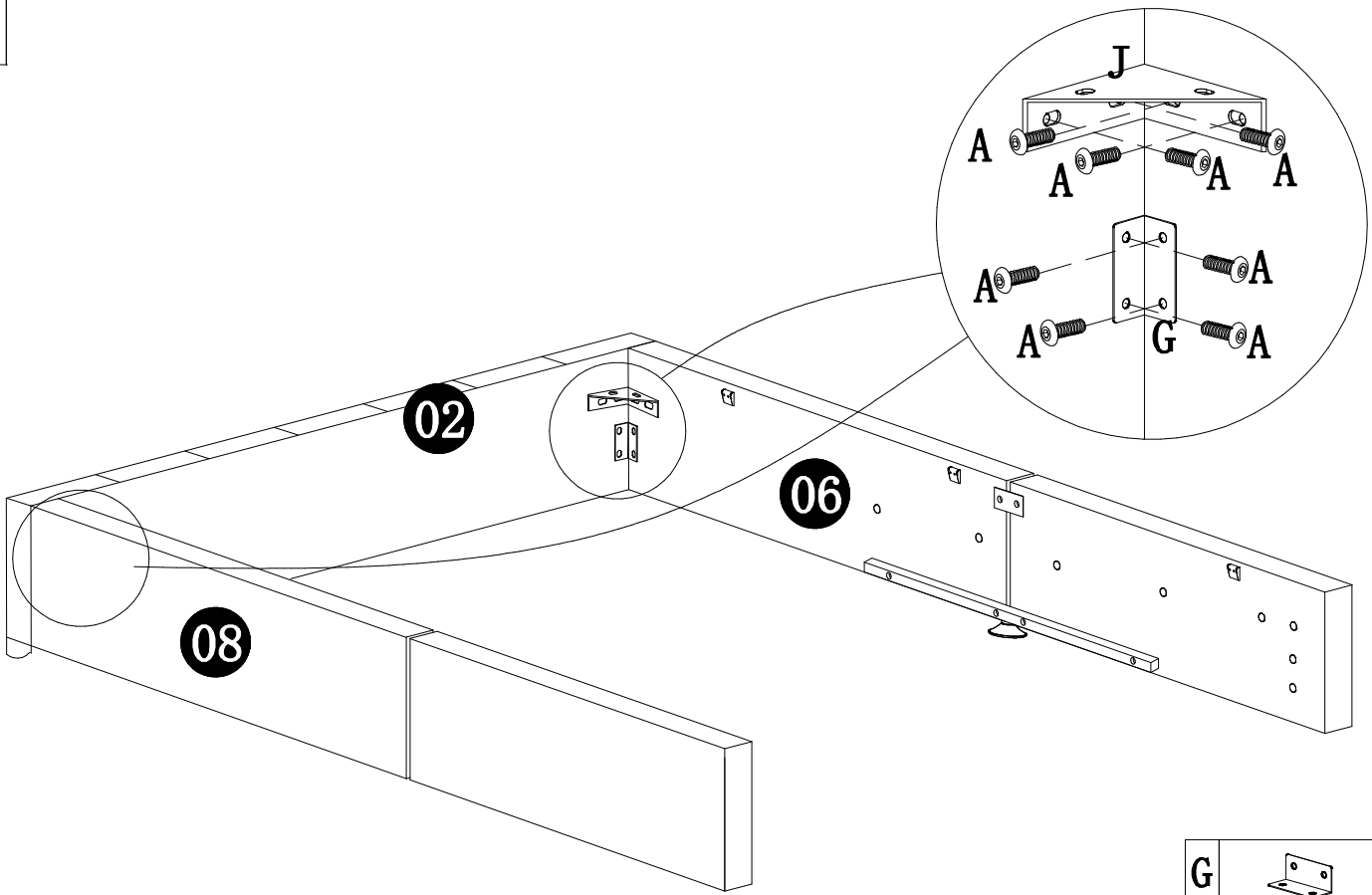

U		1
---	--	---

J		2	G		2
A		16	A		16

12

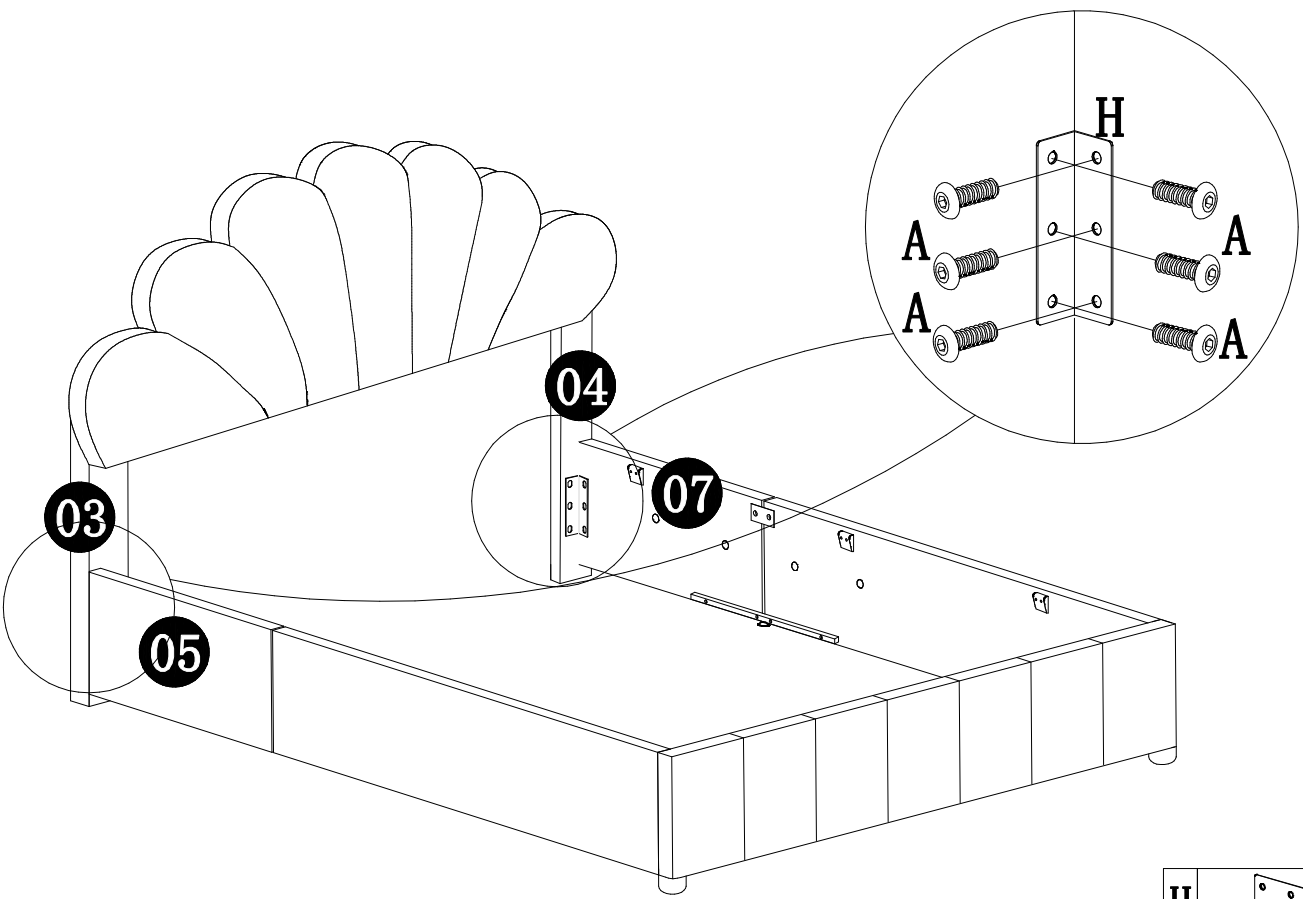



U		1
---	--	---

H		2
A		12

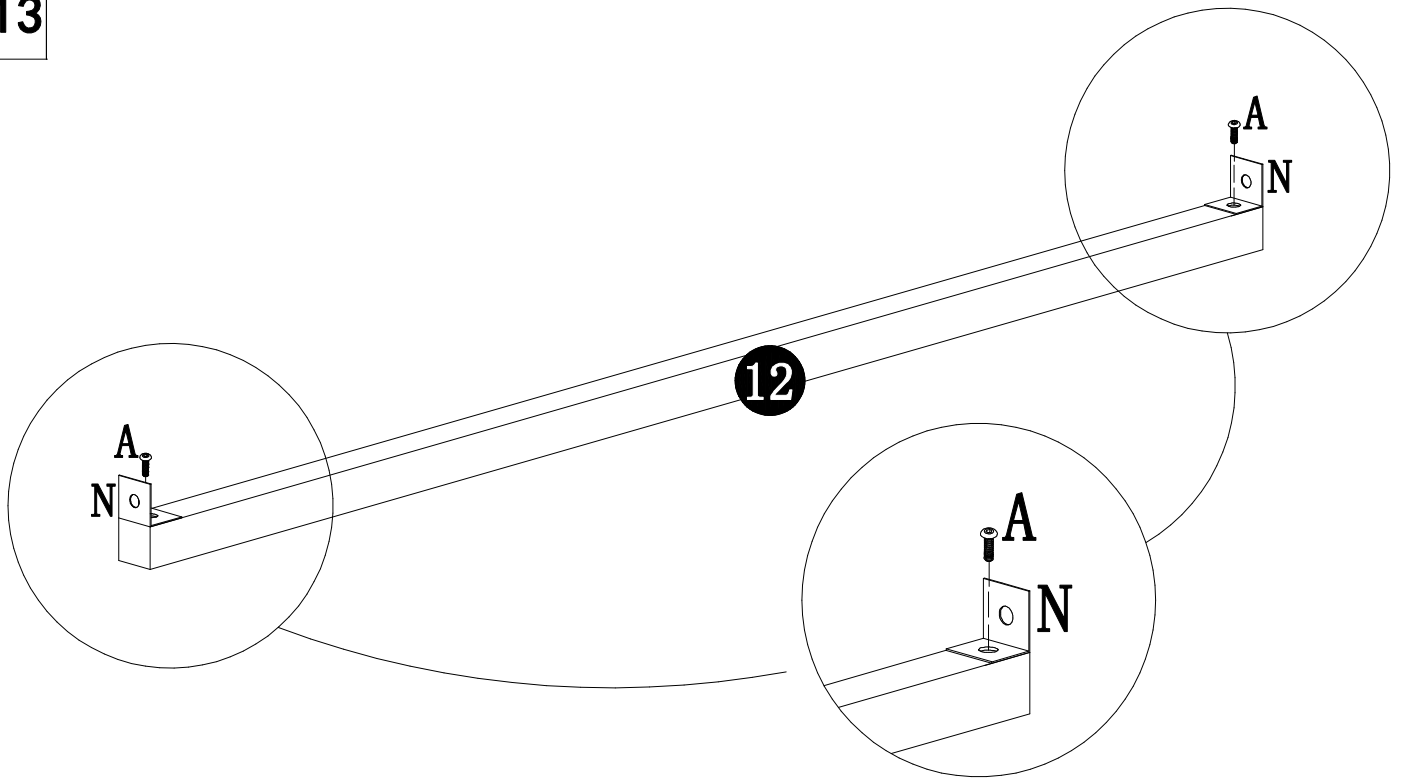
13





N		2
A		2

U		1
---	------------------------------------------------------------------------------------	---

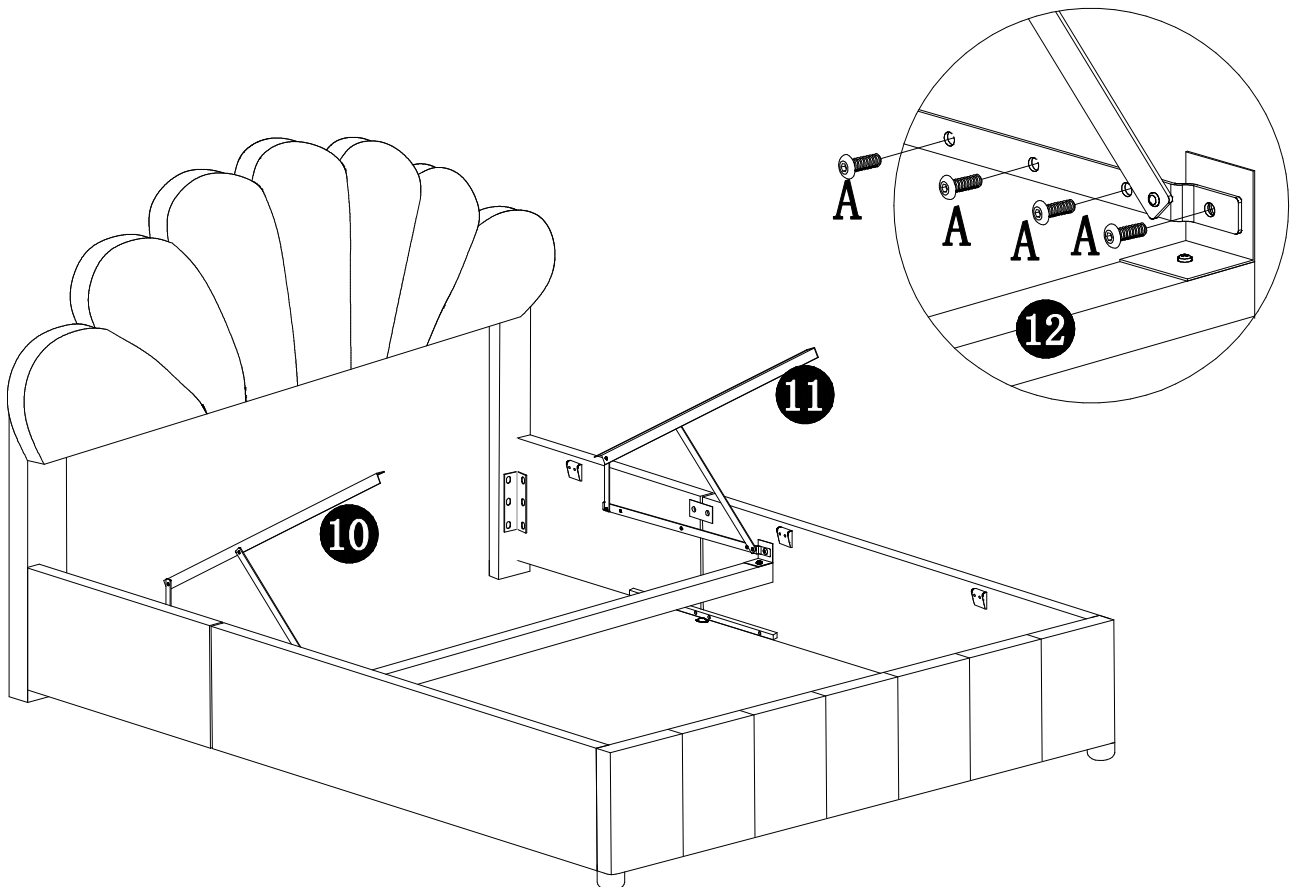
14



A		8
---	---------------------------------------------------------------------------------------	---



U		1
---	------------------------------------------------------------------------------------	---

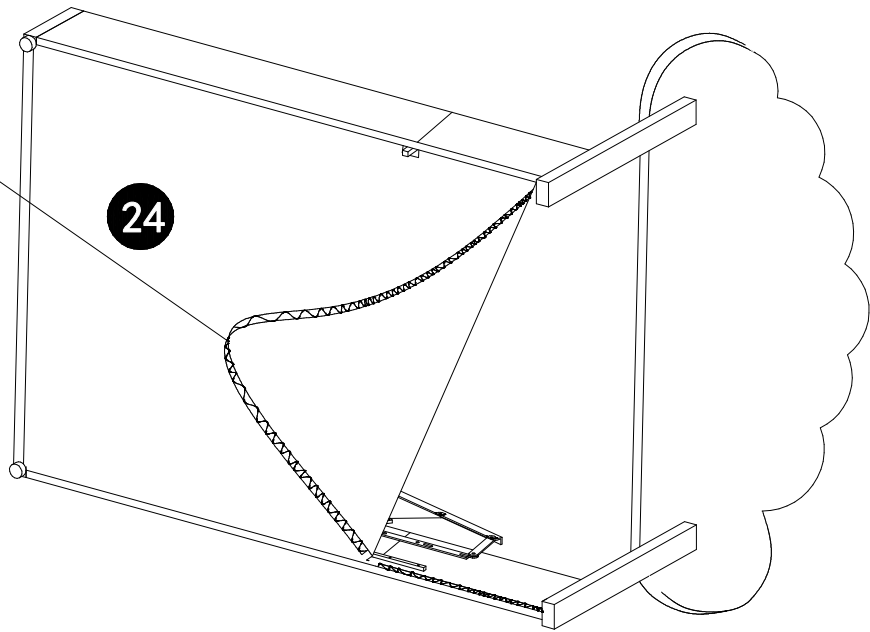

15

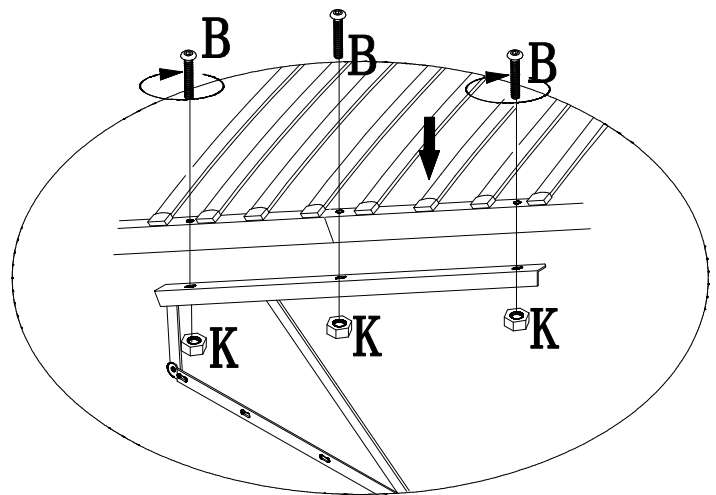
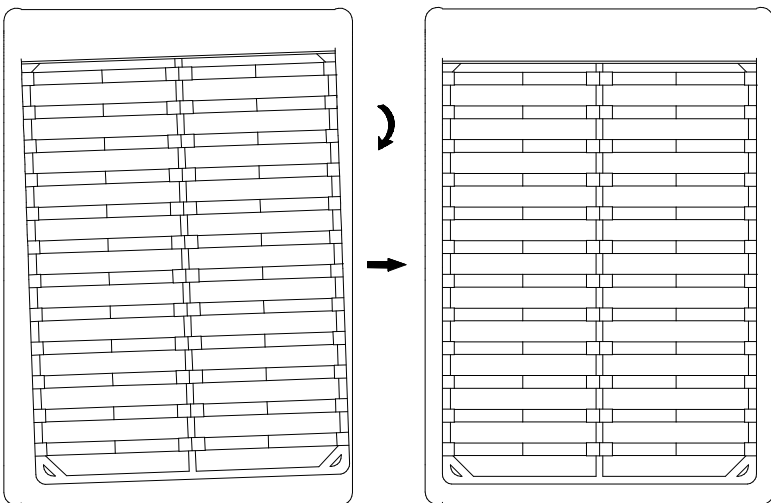

16



V		1
U		1

K		6
B		6

8*50

17

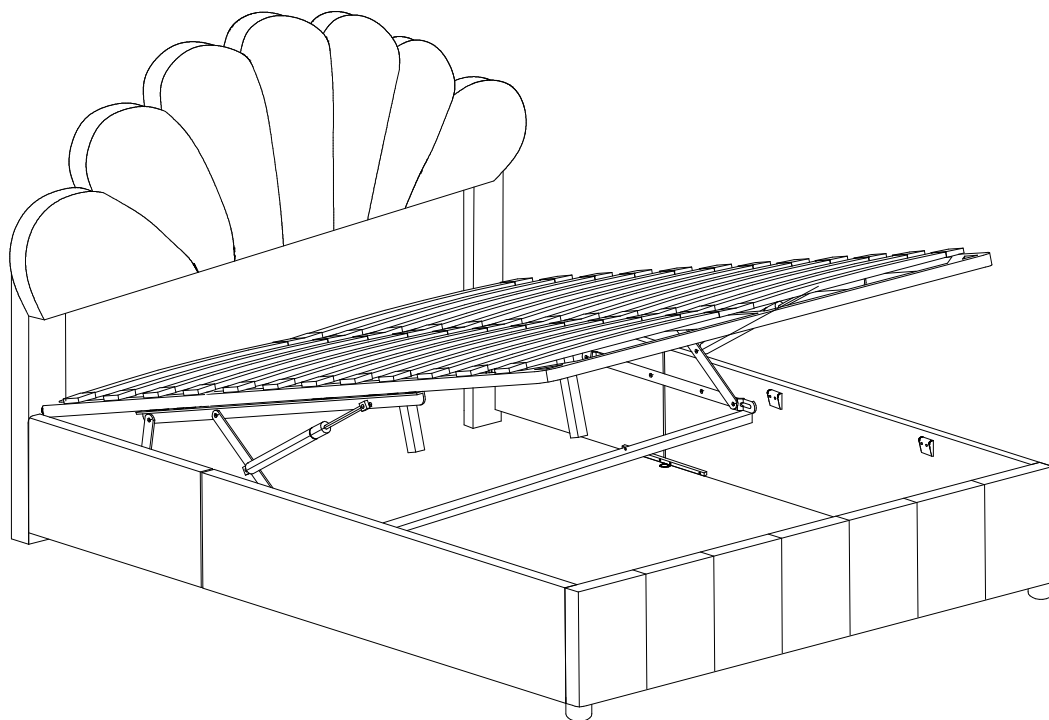
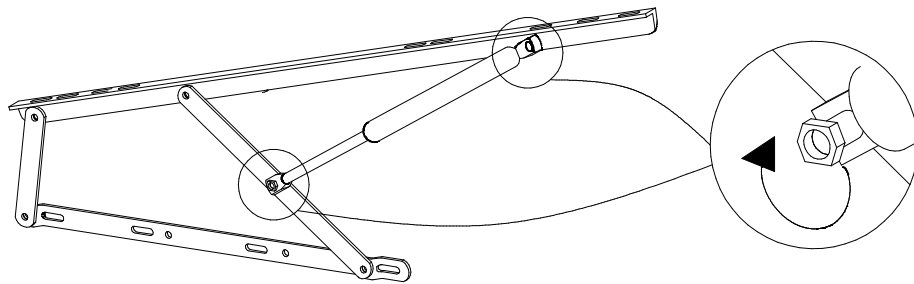

V  1

18

