

Model: RONAN
Assembly Instruction

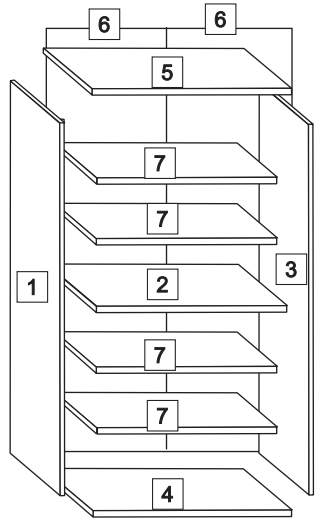

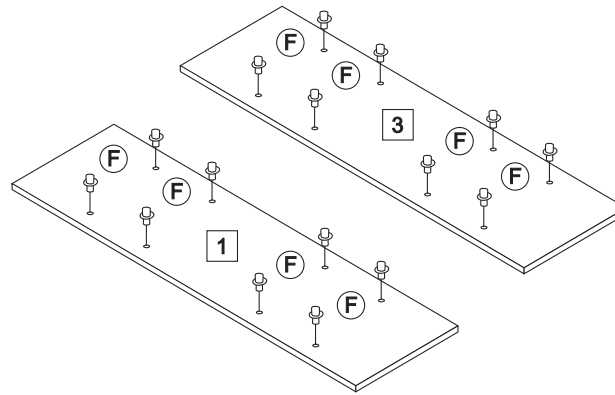





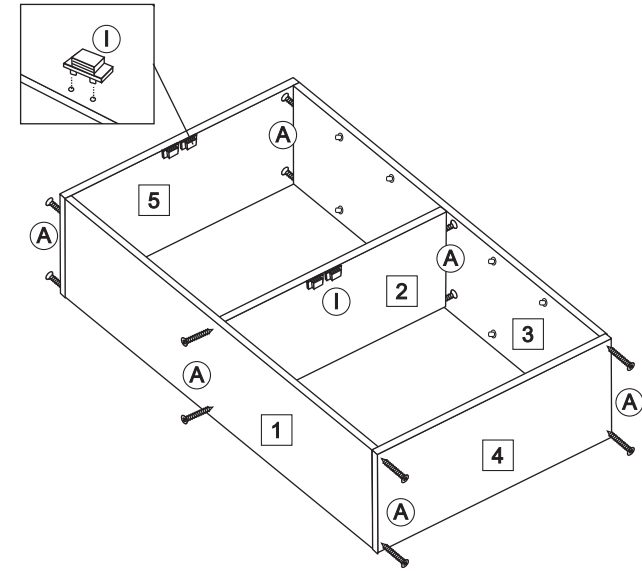



STEP 1



STEP 2



NO	HARDWARE LIST	QTY
A	M4X32MM screw 	12
B	M4X25MM screw 	4
C	M3.5X14MM screw 	36
D	Nail 	38
E	Handle 	4
F	Plastic Shelf Support 	20
G	Door Holder 	8
H	Leg 	4
I	Magnet 	4
J	Magnet Plate 	4

STEP 3

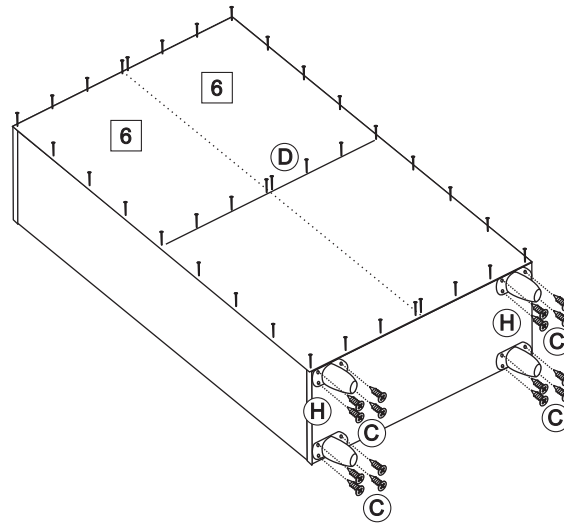

STEP 4

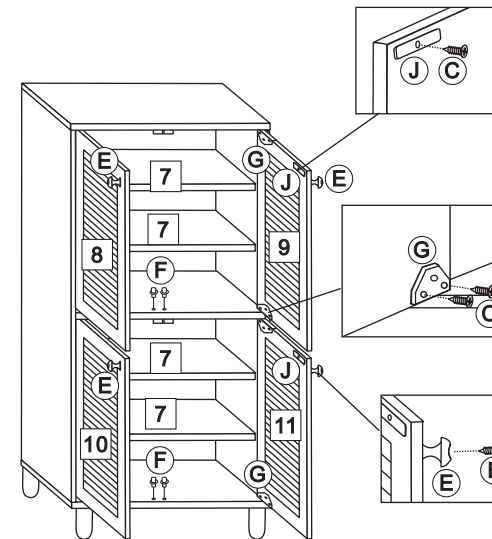

complete

