

260-000021

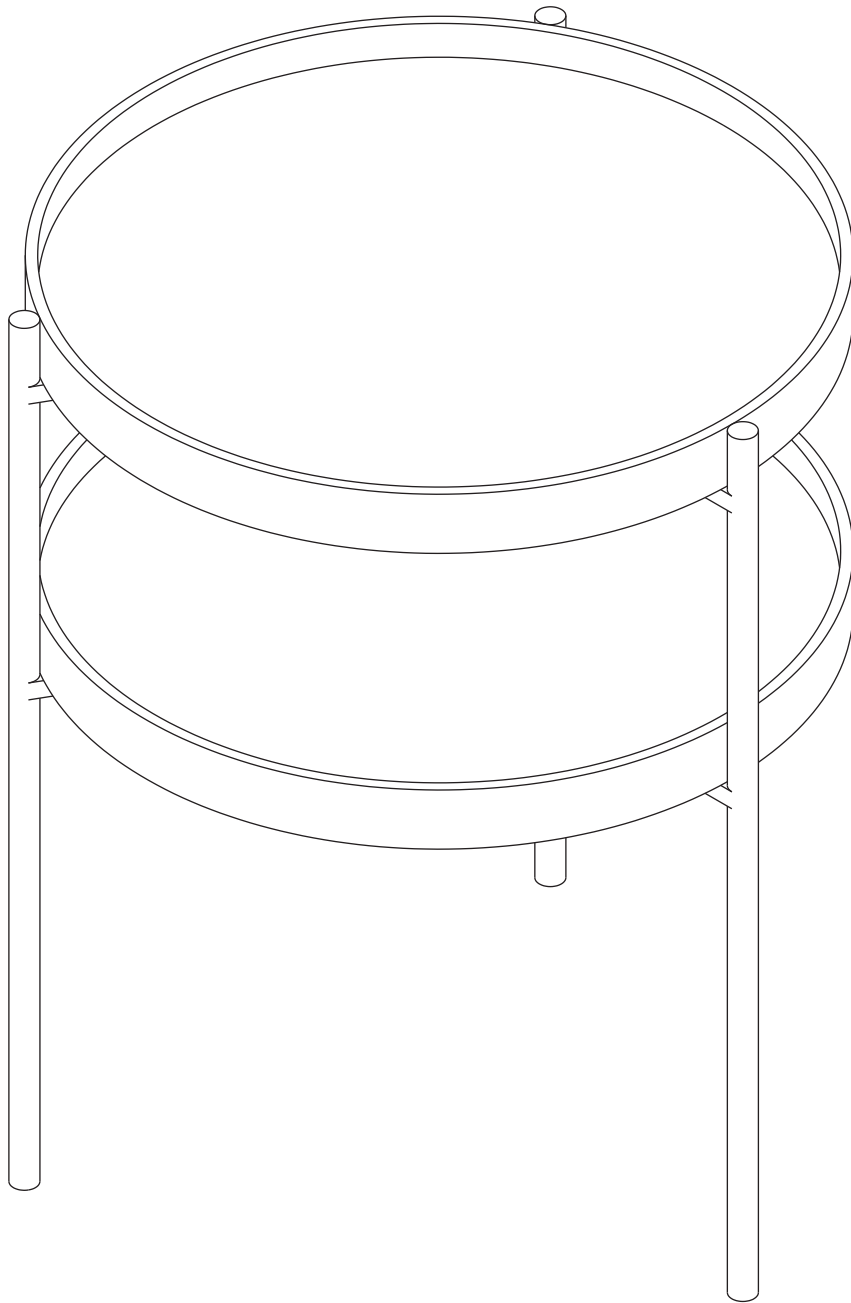

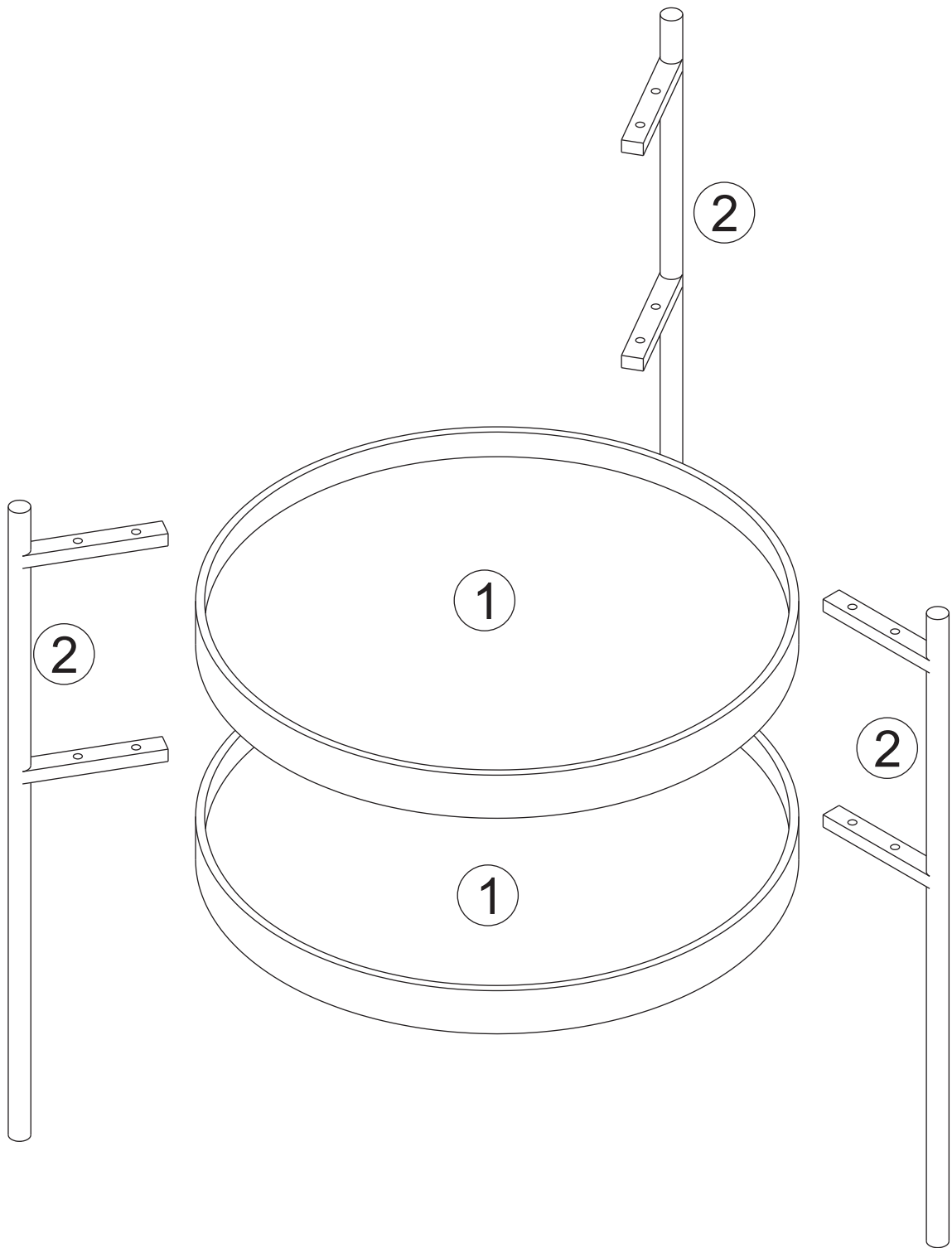
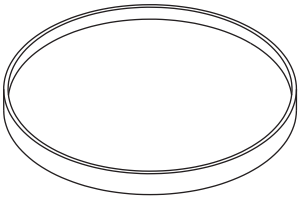
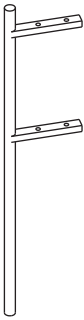
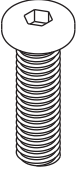
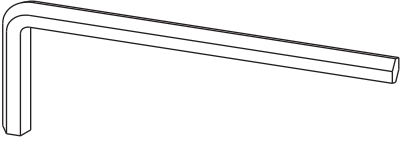

<p>①</p>  <p>x2</p>	<p>②</p>  <p>x3</p>	
<p>Ⓐ</p>  <p>x12</p>	<p>Ⓑ</p>  <p>x1</p>	

1

A x 8
B x 1

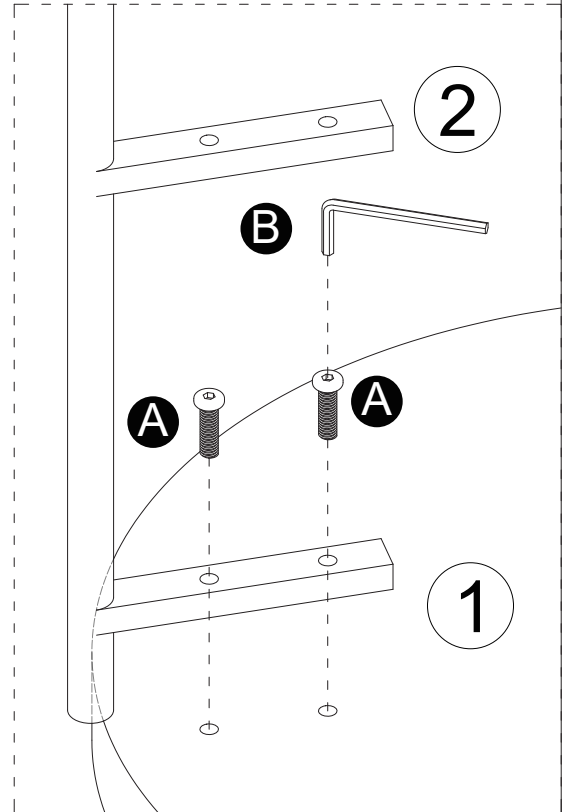
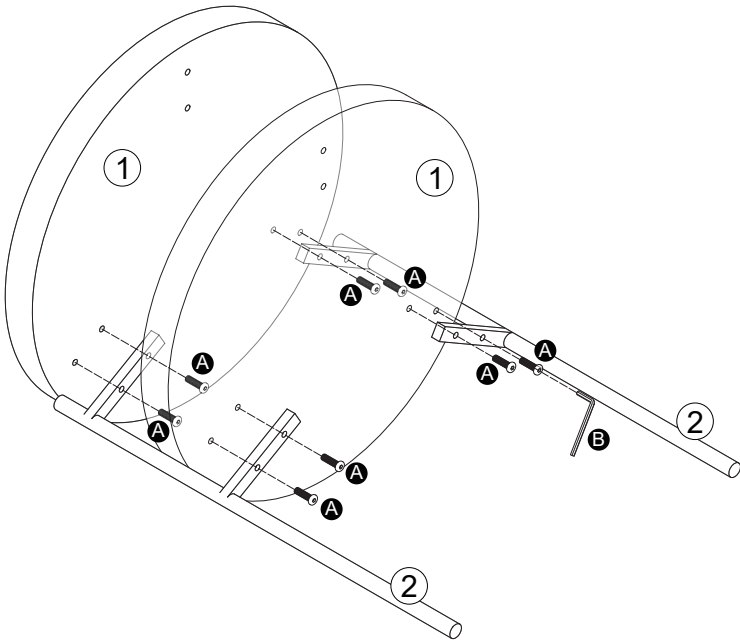

2

A x 4
B x 1

