

INSTRUCTION MANUAL

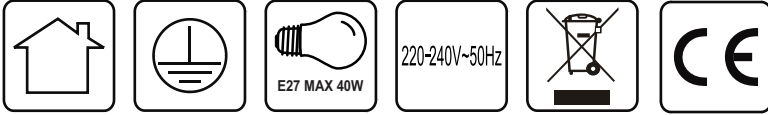

317-000006

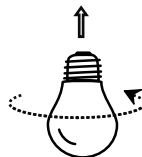
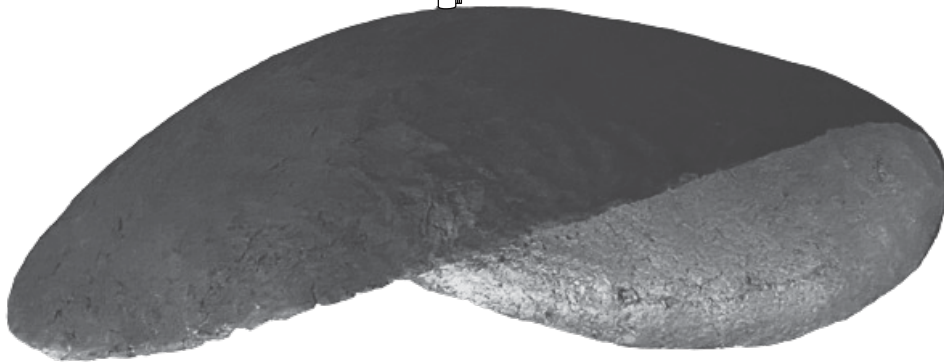
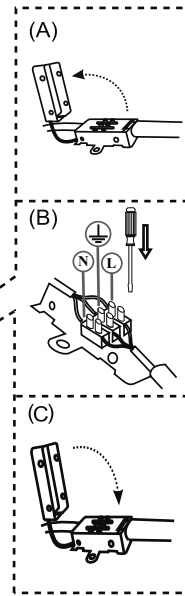
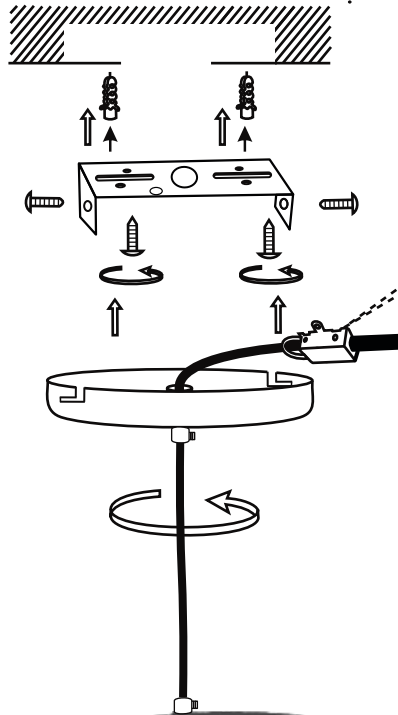
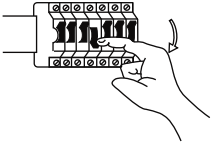

PARTS INCLUDED:

LABEL	DESCRIPTION	PICTURE	QTY
A	PLASTIC ANCHORS		2 PCS.
B	MOUNTING SCREWS		2 PCS.
C	CANOPY SCREWS		2 PCS.
D	MOUNTING BRACKET		1 PC.
E	CEILING CAP / CANOPY		1 PC.
F	TERMINAL BLOCK		1 PC.
G	CORD GRIP		2 PCS.
H	WIRE CABLE		1 PC.

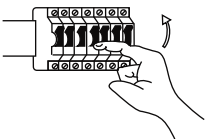

INSTRUCTION MANUAL

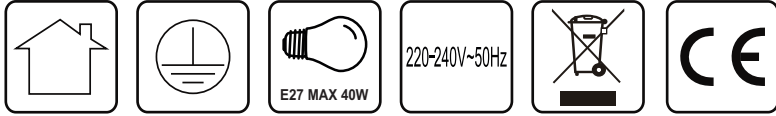

317-000006

1. SHUT OFF THE ELECTRICAL SUPPLY FROM MAIN FUSE BOX / CIRCUIT BREAKER
2. CAREFULLY REMOVE ALL PARTS FROM THE BOX AND REMOVE ALL PLASTIC COVERING
3. AFFIX PLASTIC ANCHORS (A) ONTO THE CEILING
4. GENTLY PULL WIRING FROM CEILING OUTLET BOX AND ALLOW THEM TO HANG
5. CONNECT FIXTURE GROUND WIRE (GREEN/YELLOW) IN THE TERMINAL BLOCK (F) AND THE HOUSE EARTH WIRE FROM THE CEILING OUTLET BOX USING A FLAT-HEAD SCREW-DRIVER (NOT PROVIDED)
6. CONNECT FIXTURE LIVE WIRE (BROWN) IN THE TERMINAL BLOCK (F) AND THE HOUSE LIVE WIRE FROM THE CEILING OUTLET BOX USING A FLAT-HEAD SCREW-DRIVER (NOT PROVIDED)
7. CONNECT FIXTURE NEUTRAL WIRE (BLUE) IN THE TERMINAL BLOCK (F) AND THE HOUSE NEUTRAL WIRE FROM THE CEILING OUTLET BOX USING A FLAT-HEAD SCREW-DRIVER (NOT PROVIDED)
8. DO NOT REVERSE LIVE & NEUTRAL CONNECTIONS
9. ATTACH MOUNTING BRACKET (D) TO THE CEILING BY WINDING MOUNTING SCREWS (B) PROVIDED, THROUGH THE BRACKET (D) AND INTO THE PLASTIC ANCHORS (A) (USE A PHILLIP-HEAD SCREW-DRIVER, NOT PROVIDED)
10. SUSPEND CEILING CAP / CANOPY (E) FROM THE MOUNTING BRACKET (D) USING CANOPY SCREWS (C) PROVIDED
11. SCREW A BULB INTO THE ELECTRIC HOLDER
12. ENSURE THE WIRING IS WELL CONNECTED AND THE BULB IS WELL FITTED
13. RESTORE POWER TO THE OUTLET BOX TO ILLUMINATE

SAFETY INSTRUCTIONS

PLEASE STUDY INSTRUCTION MANUAL AND BELOW INFORMATION CAREFULLY BEFORE INSTALLING OR USING. KINDLY KEEP THIS USER MANUAL FOR FURTHER REFERENCE

1. THE LUMINAIRE MAY ONLY BE INSTALLED BY AUTHORISED AND QUALIFIED TECHNICIANS IN ACCORDANCE WITH VALID REGULATIONS FOR ELECTRICAL INSTALLATION
2. MAINTENANCE OF THE LUMINAIRE IS LIMITED TO ITS SURFACE. DURING MAINTENANCE NO MOISTURE CAN COME INTO CONTACT WITH ANY ARREAS OF THE TERMINAL CONNECTIONS.
3. ELECTRICAL SUPPLY MUST BE SWITCHED OFF AT THE OUTSET, PREFERABLY BY MEANS OF A SWITCH IN THE DISTRIBUTION BOX, BEFORE ANY INSTALLATION, MAINTENANCE OR REPAIR WORK IS UNDERTAKEN
4. IF ANY DOUBT CONSULT A PROFESSIONAL, TAKING LOCAL INSTALLATION REQUIREMENTS INTO ACCOUNT. SOME COUNTRIES STIPULATE THAT LIGHTING MAY BE INSTALLED ONLY BY REGISTERED INSTALLERS.
5. CLAMPING SCREWS IN ELECTRICAL CONNECTIONS MUST BE ADEQUATELY TIGHTENED. THIS IS PARTICULARLY THE CASE WITH 12V LOW VOLTAGE CONDUCTORS.
6. CLEAN WITH A DRY CLOTH OR BRUSH, USE NO SOLVENTS OR ABRASIVES. AVOID DAMPNES ON ALL ELECTRICAL COMPONENTS.
7. TAKE ACCOUNT OF ALL AVAILABLE TECHNICAL INFORMATION.
8. TAKE NOTE OF THE SYMBOLS WHEN CONNECTING WIRES:
N=NEUTRAL L=LIVE =EARTH
9. TAKE NOTE OF COLOURS WHEN CONNECTING WIRES :
BLUE WIRE = NEUTRAL BROWN WIRE = LIVE GREEN/YELLOW WIRE = EARTH



FOR INDOOR USE ONLY, WHERE DIRECT CONTACT WITH WATER IS IMPOSSIBLE



PROTECTION CLASS I: THE FITTING MUST BE EARTHED



THE TYPE OF BULB TO BE USED. MAXIMUM WATTAGE INDICATED IN EACH LIGHTING UNIT MUST NOT BE EXCEEDED: DIFFERENT ITEMS REQUIRE DIFFERENT KIND OF LIGHT SOURCE WITH DIFFERENT BULB ICONS



THE ARMATURE IS DESIGNED TO WORK ONLY WITH INDICATED VOLTAGE. DIFFERENT ITEMS REQUIRE DIFFERENT WORKING VOLTAGE



THIS LUMINAIRE CANNOT BE DISPOSED WITH NORMAL DOMESTIC WASTE IN STANDARD RUBBISH CAN. IT HAS TO BE BROUGHT TO A STAGING AREA FOR ELECTRICAL WASTE



THIS LUMINAIRE MEETS THE MANDATORY REQUIREMENTS FOR CE CERTIFICATION