

361-000001

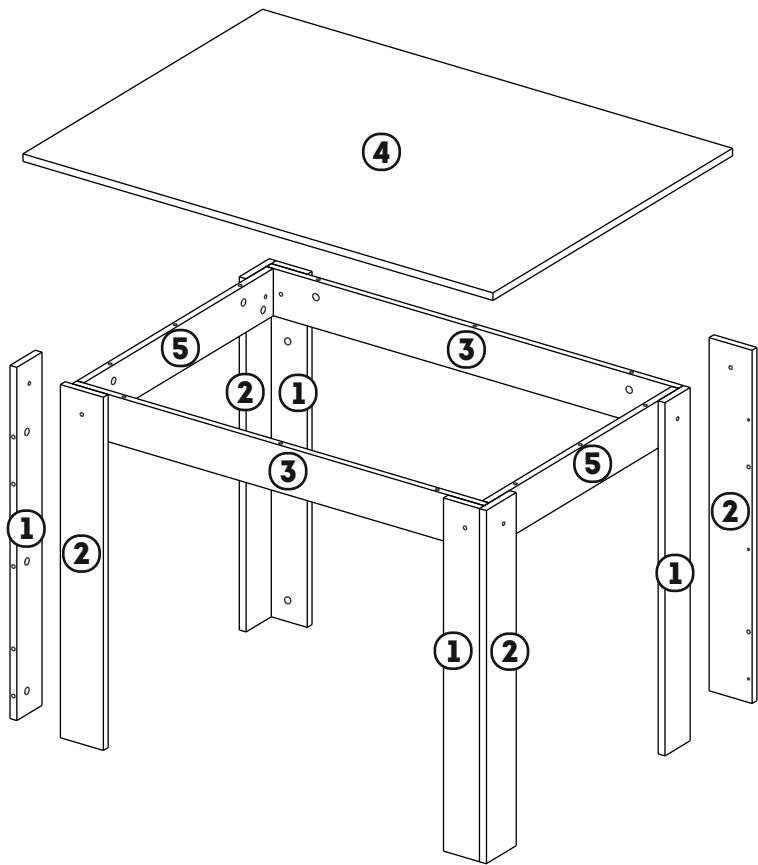

No	a*b	X	Pack
1	750x84	4	1/1
2	750x101	4	1/1
3	100x968	2	1/1
4	1104x804	1	1/1
5	100x636	2	1/1

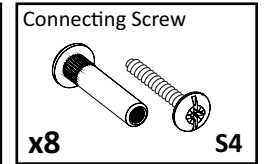

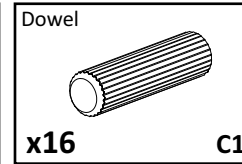
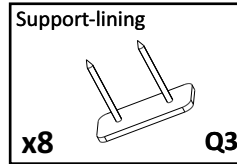
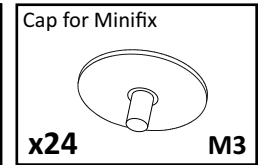
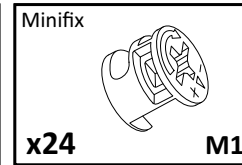
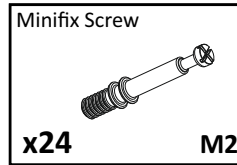
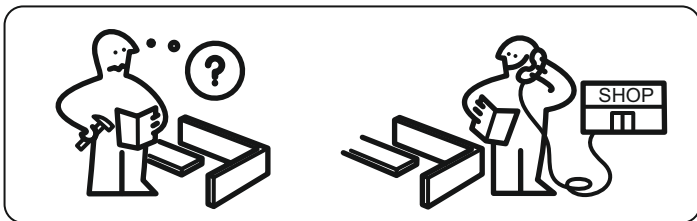
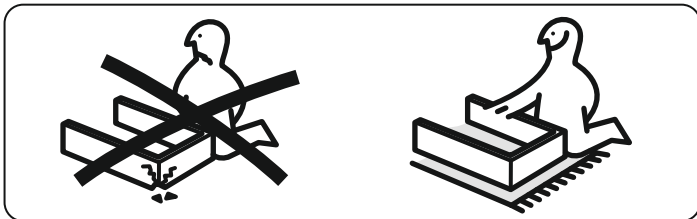
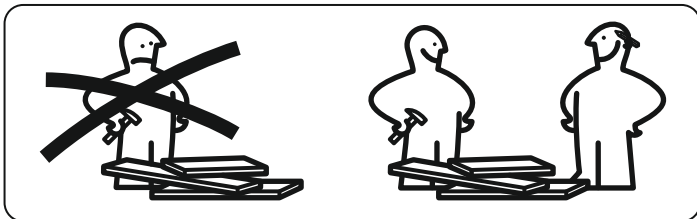

## GENERAL TECHNICAL INSTRUCTIONS FOR FURNITURE ASSEMBLY

- CHECK COMPATIBILITY OF PARTS AND ACCESSORIES BEFORE ASSEMBLY.
- FOR FURNITURE ASSEMBLY, WE RECOMMEND USING THE SERVICES OF QUALIFIED SPECIALISTS.
- DO ASSEMBLY ON A SURFACE COVERED WITH CLOTH OR CARDBOARD TO PREVENT SCRATCHES.

## CARE AND MAINTENANCE OF FURNITURE

- KEEP THE FURNITURE FROM PROLONGED CONTACT WITH WATER OR HOT STEAM.
- ENSURE SUFFICIENT DISTANCE FROM ELECTRICAL APPLIANCES AND HEATERS.
- IF THERE IS DIRTY ON THE FURNITURE, REMOVE IT WITH A DAMP CLOTH AND THEN WIPE IT DRY. DO NOT USE ABRASIVE MATERIALS.

# 1

Minifix



x24

M1

Dowel

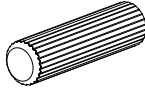

x8

C1

Minifix Screw

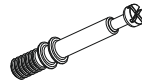

x16

M2

Connecting Screw

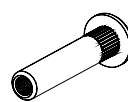

x8

S4

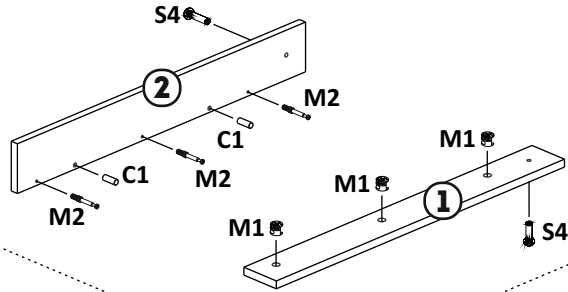
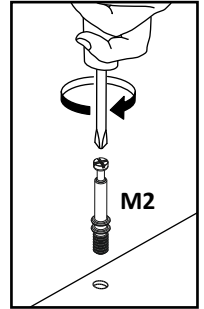

x2

x2

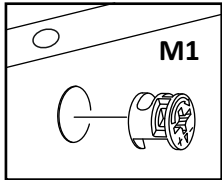
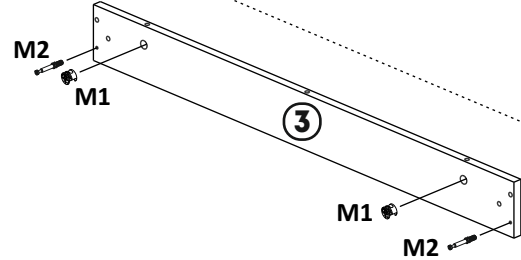
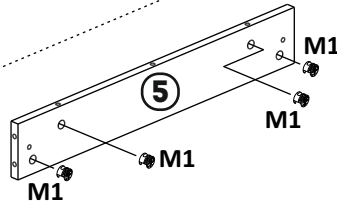

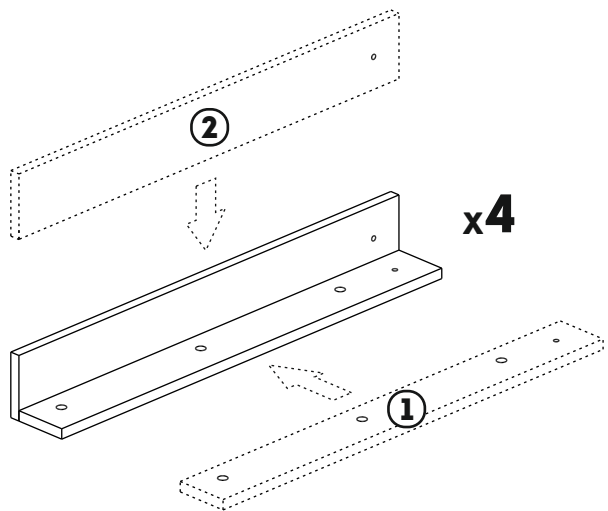
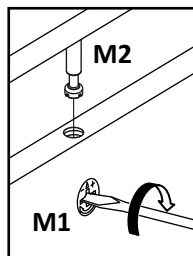
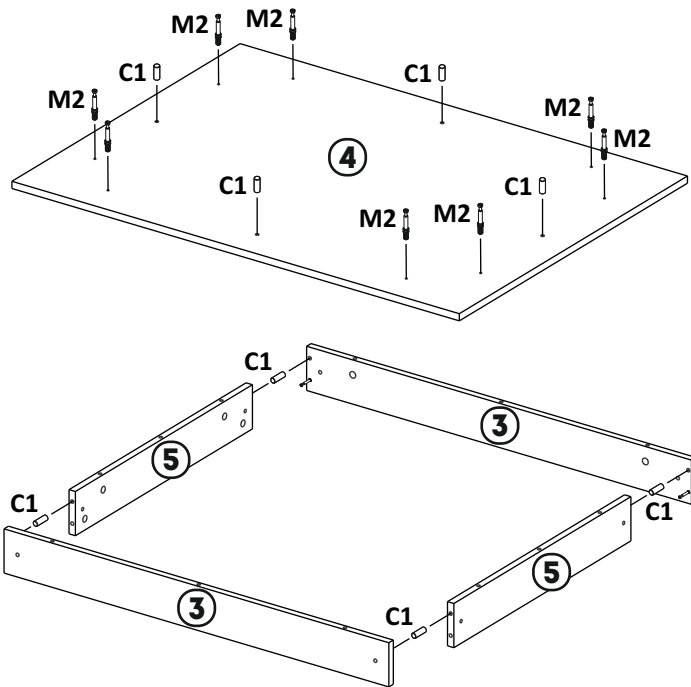
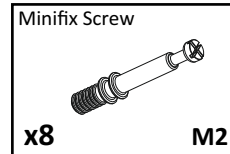
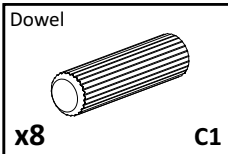
**2****3**

**4**

Connecting Screw

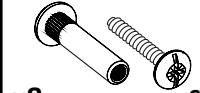

x8

S4

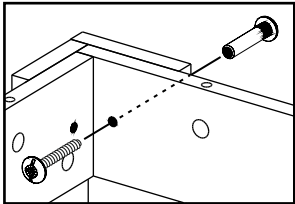
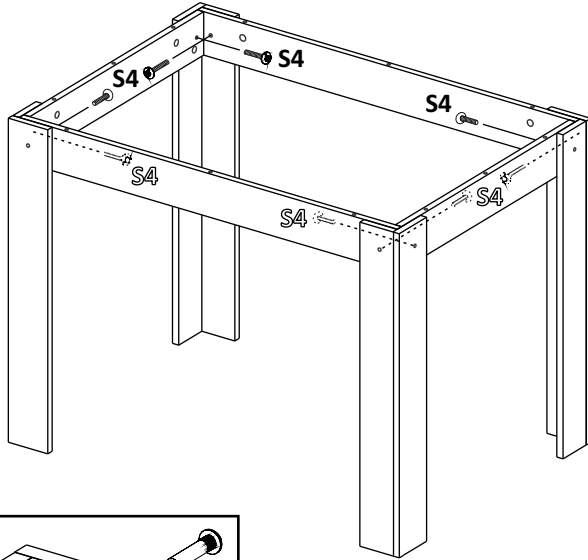
**5**

Support-lining

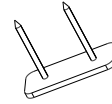

x8

Q3

