

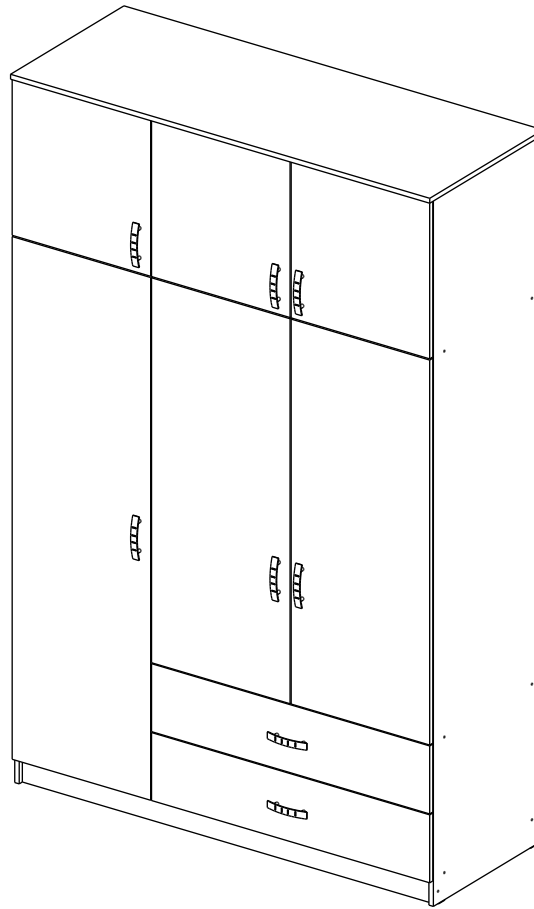

361-000066

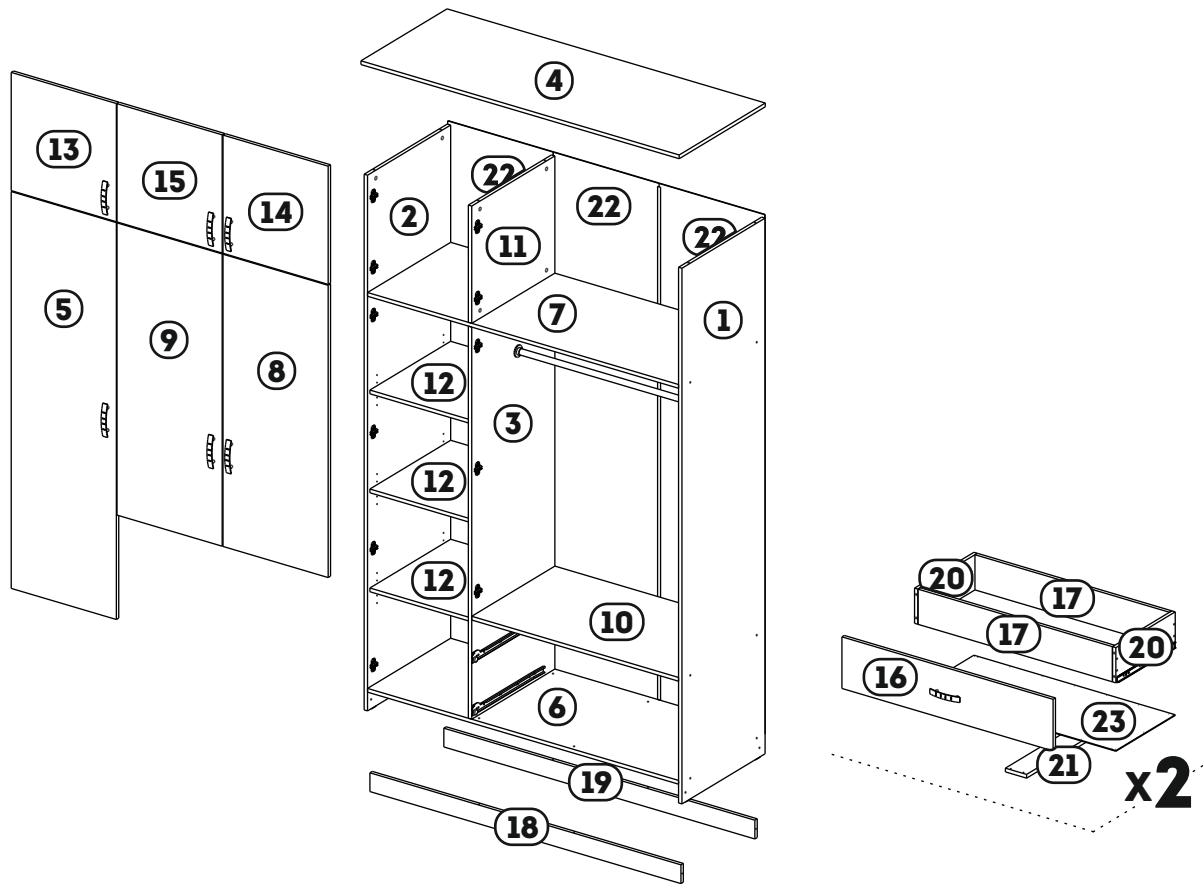



| No | a*b | X | Pack |
|----|----------|---|------|
| 1 | 2284x560 | 1 | 1 |
| 2 | 2284x560 | 1 | 1 |
| 3 | 1672x560 | 1 | 4 |
| 4 | 1501x580 | 1 | 3 |
| 5 | 1692x496 | 1 | 2 |
| 6 | 1467x560 | 1 | 3 |
| 7 | 1467x560 | 1 | 4 |
| 8 | 1246x496 | 1 | 2 |
| 9 | 1246x496 | 1 | 2 |
| 10 | 976x560 | 1 | 4 |
| 11 | 500x560 | 1 | 4 |
| 12 | 476x544 | 3 | 5 |
| 13 | 504x496 | 1 | 5 |
| 14 | 504x496 | 1 | 5 |
| 15 | 504x496 | 1 | 5 |
| 16 | 220x996 | 2 | 3 |
| 17 | 918x150 | 4 | 3 |
| 18 | 1467x80 | 1 | 3 |
| 19 | 80x1467 | 1 | 3 |
| 20 | 400x150 | 4 | 2 |
| 21 | 100x400 | 2 | 2 |
| 22 | 2216x498 | 3 | 1 |
| 23 | 950x400 | 2 | 1 |

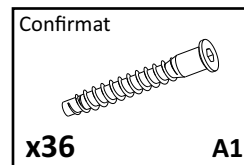
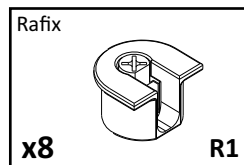
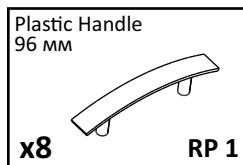
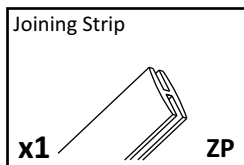
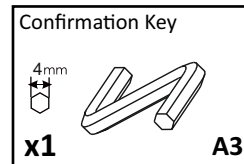
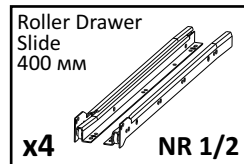
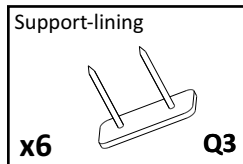
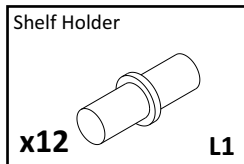
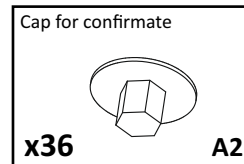
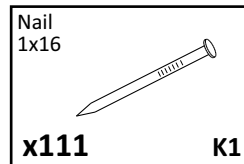
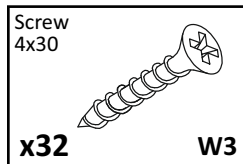
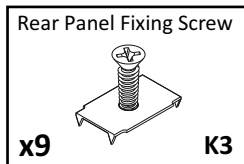
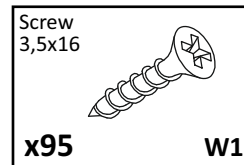
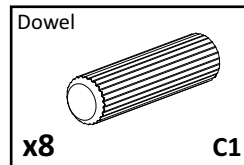
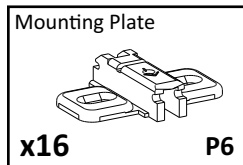
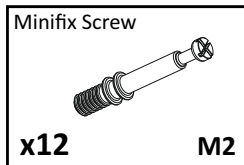
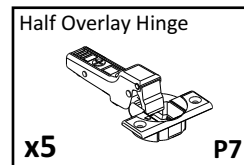
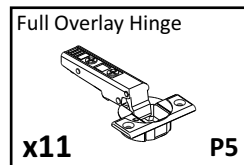
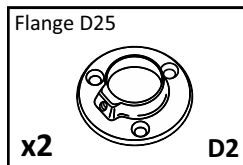
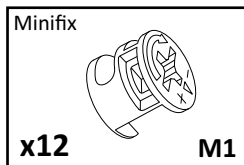

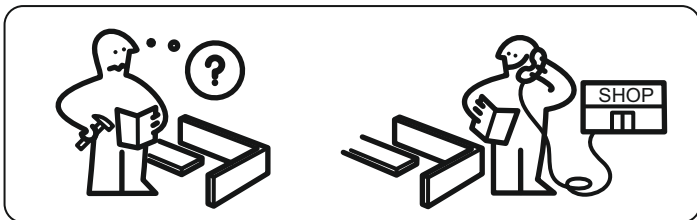
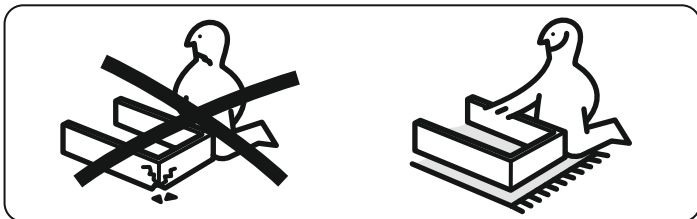
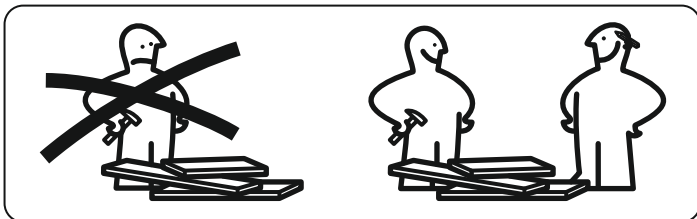

GENERAL TECHNICAL INSTRUCTIONS FOR FURNITURE ASSEMBLY

- CHECK COMPATIBILITY OF PARTS AND ACCESSORIES BEFORE ASSEMBLY.
- FOR FURNITURE ASSEMBLY, WE RECOMMEND USING THE SERVICES OF QUALIFIED SPECIALISTS.
- DO ASSEMBLY ON A SURFACE COVERED WITH CLOTH OR CARDBOARD TO PREVENT SCRATCHES.

CARE AND MAINTENANCE OF FURNITURE

- KEEP THE FURNITURE FROM PROLONGED CONTACT WITH WATER OR HOT STEAM.
- ENSURE SUFFICIENT DISTANCE FROM ELECTRICAL APPLIANCES AND HEATERS.
- IF THERE IS DIRTY ON THE FURNITURE, REMOVE IT WITH A DAMP CLOTH AND THEN WIPE IT DRY. DO NOT USE ABRASIVE MATERIALS.

1

Mounting Plate

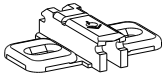

x16

P6

Roller Drawer Slide
400 mm

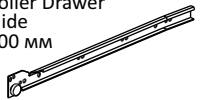

x4

NR 1

Minifix



x12

M1

Screw
3,5x16

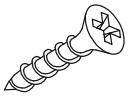

x12

W1

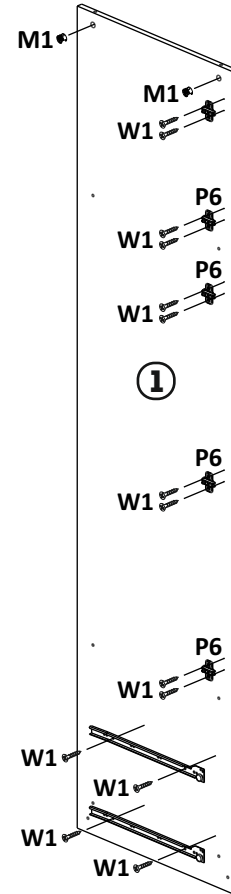
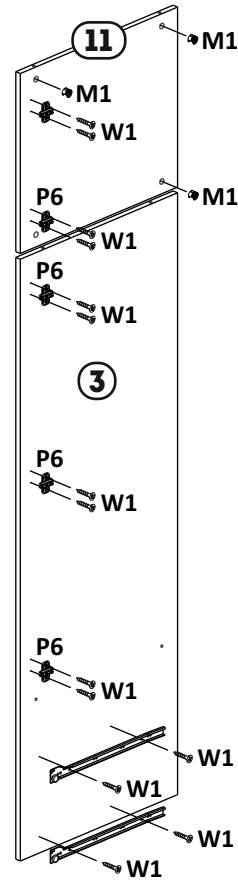
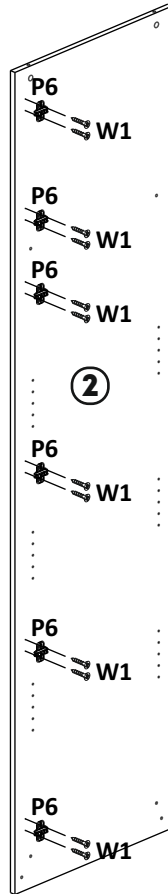
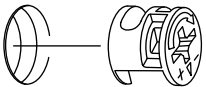

2

Confirmat

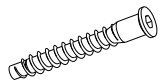

x4

A1

Minifix Screw

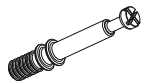

x2

M2

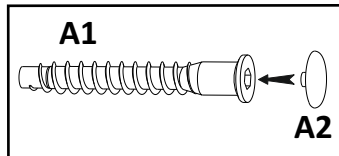
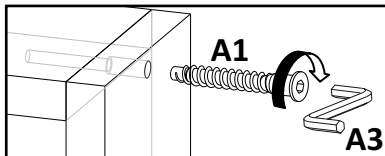
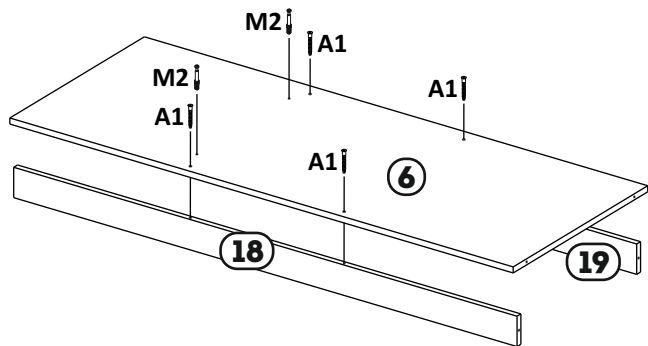
**3**

Confirmat

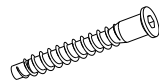

x8

A1

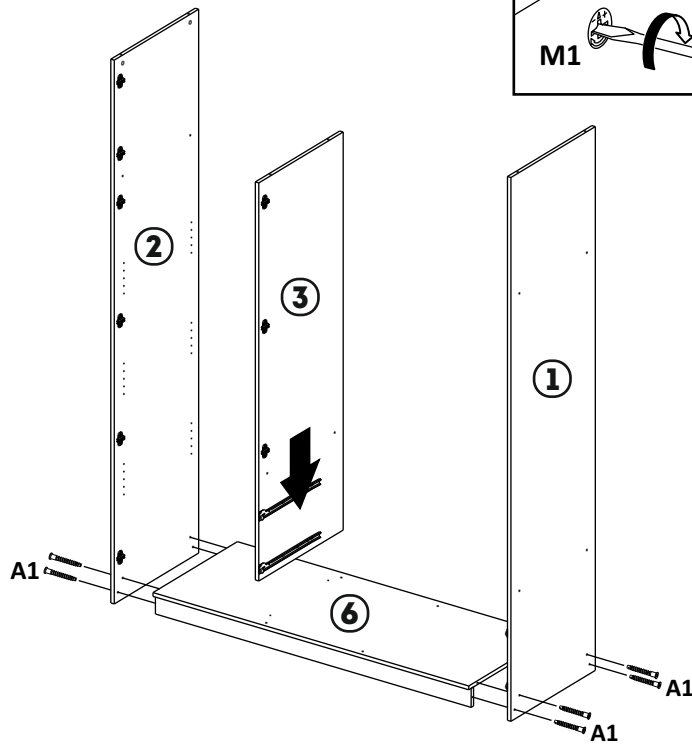
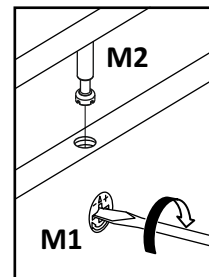

4

Minifix Screw

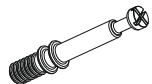

x4

M2

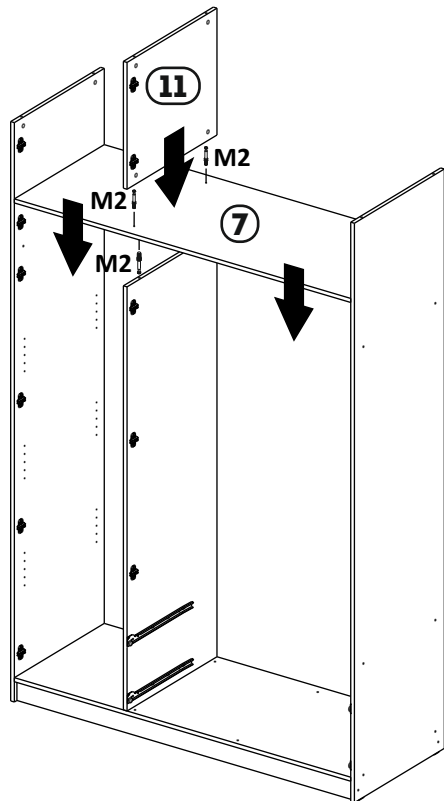
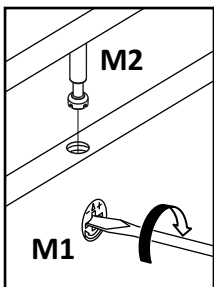

5

Minifix Screw

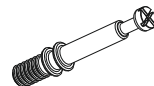

x6

M2

Confirmat

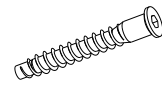

x8

A1

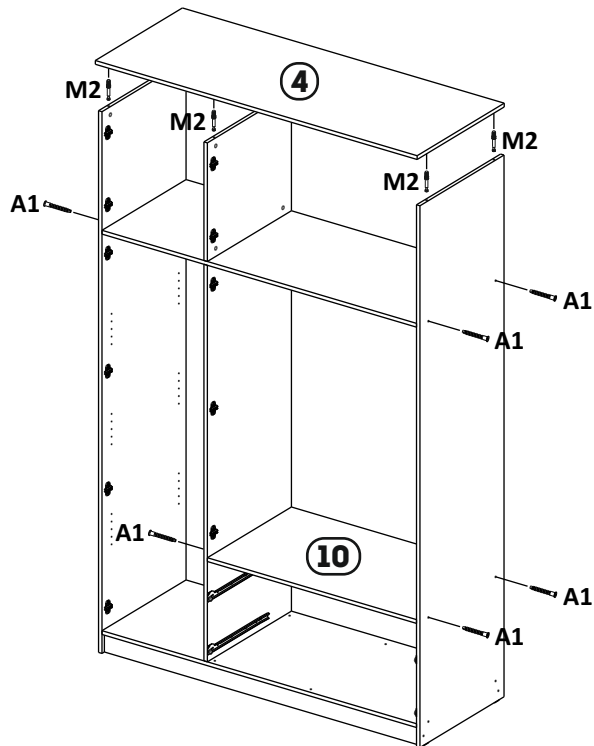

6

Rear Panel Fixing Screw



x9

K3

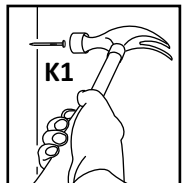
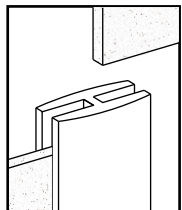

K1

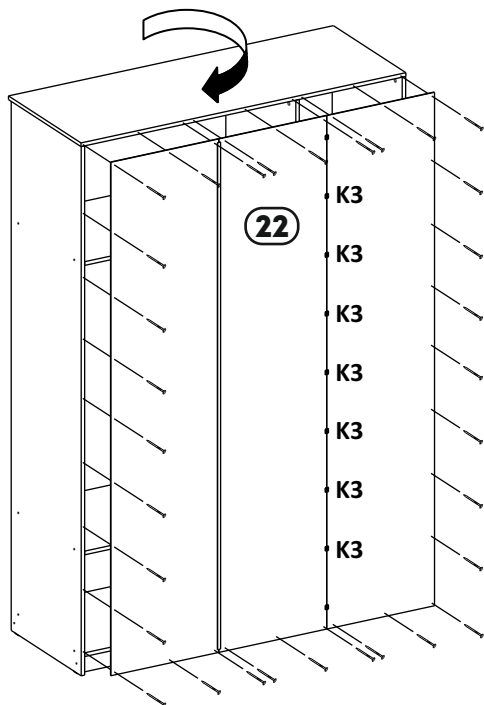
**7**

Confirmat

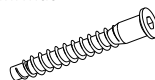

x8

A1

Cap for confirmate



x8

A2

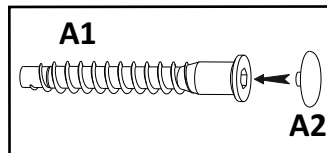
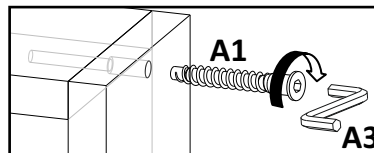
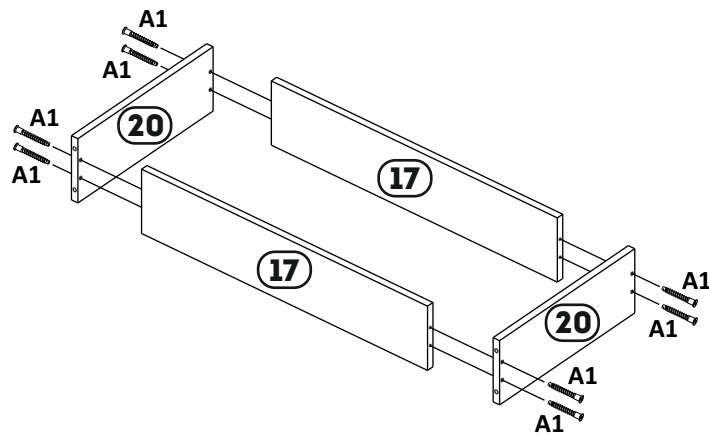
**8**

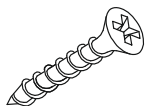
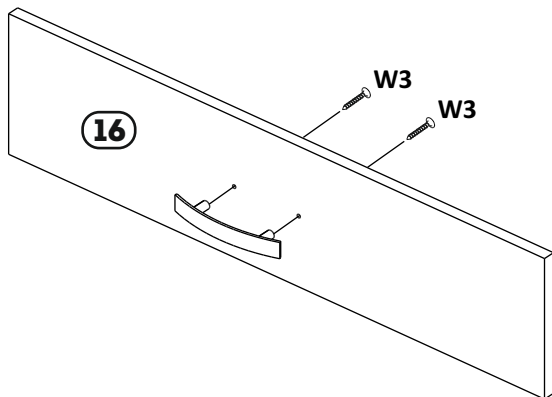
8Screw
4x30**x4****W3**Plastic Handle
96 mm**x2****RP 1****9**

Dowel

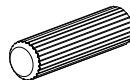
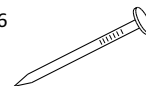
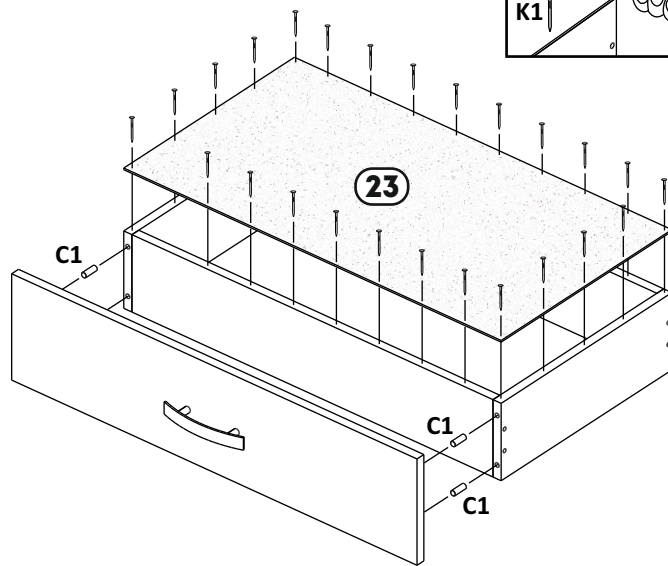
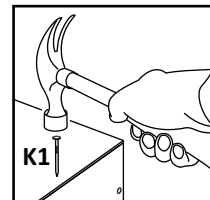
**x4****C1**Nail
1x16**x26****K1**

10

Roller Drawer
Slide
400 mm

x1

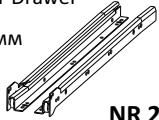

NR 2

Screw
3,5x16

x4

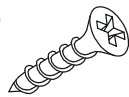

W1

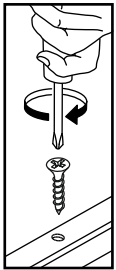
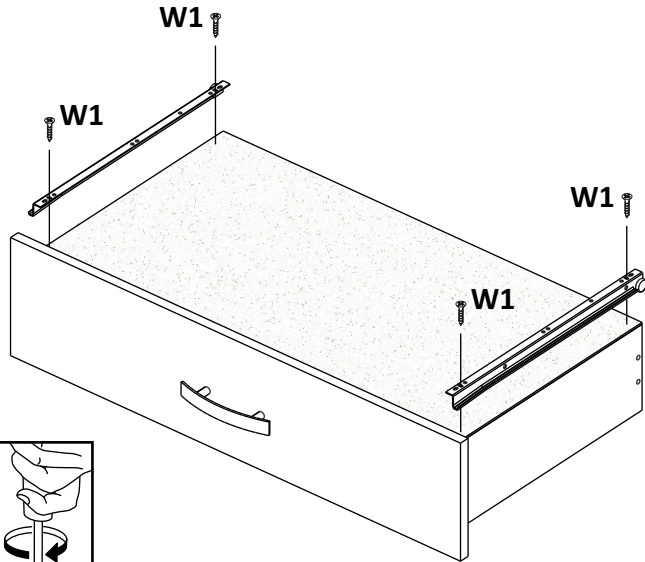

11

Screw
4x30

x4

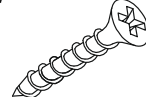

W3

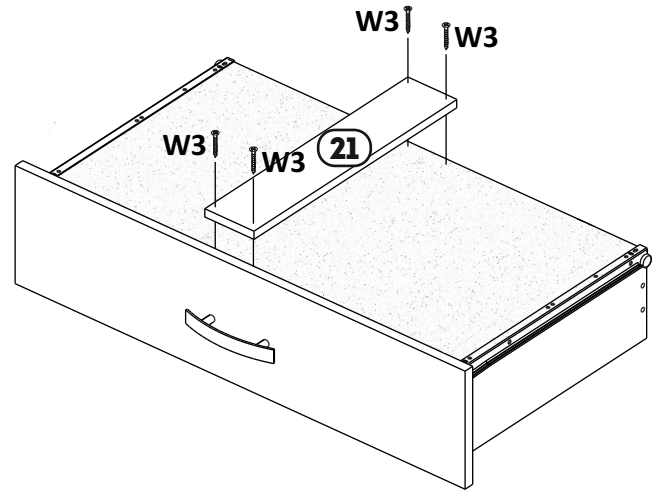

12

Screw
3,5x30

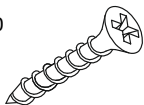

x4

W3

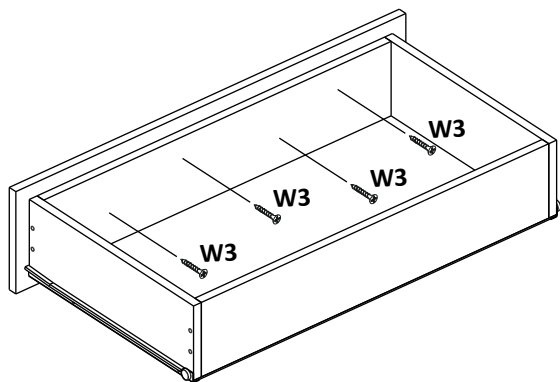

13

Full Overlay Hinge

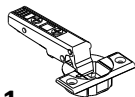

x11

P5

Half Overlay Hinge

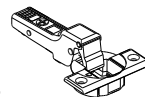

x5

P7

Screw
3,5x16

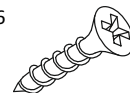

x12

W1

